

BLÜCHER® Roof Drainage Systems

Product catalogue for roof drains and pipes



BLÜCHER®

K E E P I N G U P T H E F L O W

STAINLESS STEEL DRAINAGE SYSTEMS



Safe solutions

BLÜCHER® stainless steel drainage products are installed in almost any kind of construction project, from multi-storey apartments and food processing factories to hospitals and on board prestigious cruise liners. We have specialised our competencies within four main segments:

Housing

Commercial

Industrial

Marine

The BLÜCHER® drainage system is a modular system providing numerous possible product combinations.

BLÜCHER® Drain

Floor drains for light- to heavy-duty flow and load applications.

BLÜCHER® Channel

Standard, modular or customised channels and kitchen channels for all flow and load applications.

BLÜCHER® EuroPipe

Push-fit drainage pipe-work system for soil, waste and rainwater.

Customised solutions

To ensure that any drainage requirement can be fulfilled we are always ready to solve your special request.

Strong products

All BLÜCHER® drainage products are produced in stainless steel grade AISI 304 or optionally grade AISI 316L. This material is ideally suitable for high-quality drainage systems:

- Fire resistant
- High strength - low weight
- Environmentally friendly

Furthermore it is corrosion resistant, resistant to impacts and thermal stress and requires little maintenance.

In the BLÜCHER® drainage products the inherent qualities of stainless steel are enhanced by careful product design resulting in:

- Long product life expectancy
- Excellent hygienic properties
- Easy installation
- Whole-life cost advantages
- Excellent flow capacities

All BLÜCHER® products are chemically descaled and passivated in order to enhance the natural corrosion resistance and provide a uniform matt-silver surface finish.

All stainless steel components are manufactured from recycled materials and are 100% recyclable.

Danish quality

Founded in Denmark in 1965, BLÜCHER has developed into a leading manufacturer of stainless steel drainage systems. Today, BLÜCHER is an international company with subsidiaries and representations worldwide. The BLÜCHER Group employs more than 350 staff worldwide.

Customers all over the World appreciate our know-how, dedicated service and common sense.

Through quality stainless steel products and drainage solutions that lead waste water away, BLÜCHER is committed to the promise of keeping up the flow.

The BLÜCHER® drainage products are manufactured in Denmark using the most modern production methods and in accordance with the internationally recognised quality standard ISO 9001. Furthermore, the most respected classification societies endorse the BLÜCHER® drainage products worldwide.



Selected references around the World

Hospitals, schools, commercial kitchens, the food and beverage industry and the pharmaceutical industry are among the customers that benefit from BLÜCHER stainless steel drainage systems.

Housing

BLÜCHER® stainless steel floor drains and pipe system are used all over the World in Scandinavian-style wet bathrooms in single and multi-storey buildings.

Commercial

Queen Mary Hospital, Hvidovre hospital, Princess Alexandra Hospital, Blackpool Victoria Hospital, Queen Elizabeth Hospital, St. James Hospital, University College London Hospital, Sportcentrum Fitness First, Czàsar Swimming Pool, Sports & Aquatic Centre, International Grammar School, Collège Bellevue, Elite University, Universitat Pompeu Fabra, Augustenborgskolan, Canadian International School, North Texas State University, Elderly Citizens Home Adelaide, Old Peoples Home Budapest, Maryland State Prison, Uppsala Polishus, Oslo Opera, Hilton Hotels, Hotel Marriot, Sofitel, Novotel, The Ritz Carlton Bahrain, McDonalds, Burger King, Pizza Hut, Le Louvre, Bahrain National Museum, Ministère de L'Industri, State Library of Victoria, Royal Danish Theatre, Copenhagen Zoo, Hong Kong Disneyland, Dubai Mall, IKEA, Tesco, Coop, Metro, Carrefour, Lidl, Woolworths, Gardamoen Oslo, Copenhagen Airport, Heathrow Airport, Barcelona Airport, New Athens Airport, Orly Airport, Arlanda Airport, Helsinki Airport.

Industrial

Pfizer, GSK, Astra Zeneca, Johnson & Johnson, Aventis, Kraft, Nestlé, Danish Crown, Daloon, Tulip, Knorr, Singapore Airport Catering, Ahlgreens, Estrella, Kelloggs, CocaCola, Pepsi, Heineken, Carlsberg, Whitbread Breweries, Budweiser, Tropicana Juice Processing, Absolut Vodka. Nestlé, Arla Food, Danone, Unilever, Almarai Dairy. Mercedes, Renault, L'Oreal, Sony, BASF, 3M, IBM World Headquarters, Honeywell, Colgate Palmolive, Royal Copenhagen, Hella.

Marine

Freedom of the Seas, Liberty of the Seas, Norwegian Star, Color Magic, Pride of Hawaii, Galaxy, AIDA Diva, Celebrity Solstice. MY Platinum (Dubai Ports Authority), M/S Caravelle (Jade Yachts), Safari (Blohm & Voss) Lady Haya (Pesaro), Pelorus (Lürssen Kröger Werft), Oceanco Kusch Yachts Agentur. 3 vehicle carriers and 10 container ships (MHI Japan), 6 container vessels (AP Møller), 35 commercial vessels (Mawai China), 24 container vessels (Dalian Shipyards China). Agbami Off Shore, Consafe-Aberdeen Oil Platform Bingo I & Bingo II Offshore Oil Rigs. Auxillary vessel (British Navy), 5 frigates (Norwegian Navy), 2 logistics vessels (Danish Navy), 2 survey vessels Dutch Navy.



BLÜCHER® DRAIN ROOF

Presentation of roof drains.	1
Roof drains for gravity.	18
Roof drains for siphonic.	20
Lower parts for roof drains.	22
Accessories for roof drains.	23
Flow rates for roof drains.	26



BLÜCHER® EUROPIPE

Pipes.	30
Fittings - Bends.	33
Fittings - Branches.	36
Fittings - Access pipes and bends.	38
Fittings - Sockets.	39
Fittings - Increases and reducers.	40
Fittings - Rat stops.	41
Accessories.	42
Pipe cutters and other tools.	44

Technical information

Information about material and maintenance.	45
---	----



Roof drainage Made to last



BLÜCHER® Drain Roof and BLÜCHER® EuroPipe

BLÜCHER offers a stainless steel roof drainage system suitable for:

- Flat roofs of all designs
- Downpipes from roofs of all designs
- Roofs with bitumen or single ply roof membrane
- Equally suitable for gravity and siphonic systems

BLÜCHER® roof drainage system comprises strong products which are capable of resisting impacts, corrosion as well as fire and require minimal maintenance.

Gravity roof drainage is used in traditional newbuild or refurbishment projects.

Siphonic roof drainage creates a flow rate approximately 3 - 5 times higher than in a gravity system.

This means that a larger roof area can be drained by fewer roof drains connected to one pipe string in smaller diameter than that required for the gravity system.

It is BLÜCHER's mission to provide a high-quality roof drainage system with roof drains easily connected to the BLÜCHER® EuroPipe pipework system, offering the customer a safe roof drainage system that minimizes installation time and ensures high performance as regards

- High flow capacity
- Ease of installation
- Non-combustibility
- Long product life

Gravity and siphonic roof drainage systems

BLÜCHER® gravity roof drainage

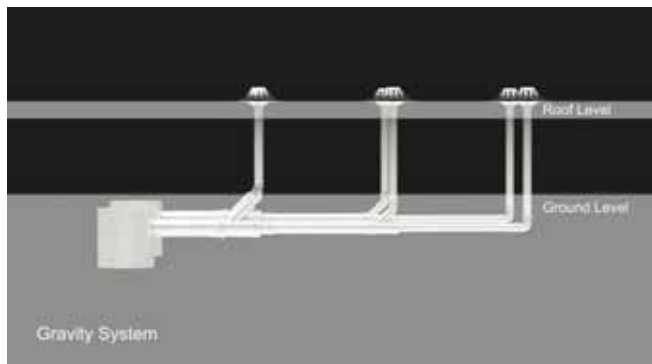

Traditional gravity system with drains spread over the roof area and water led from the roof through downpipes to a below-ground pipework system

BLÜCHER® siphonic roof drainage

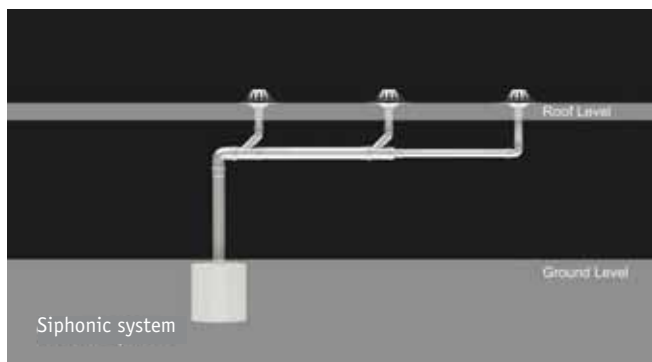

Siphonic system with fewer drains and a small-diameter horizontal pipework system underneath the ceiling. More water is transported through the pipework due to faster flow and a filled pipework system, reducing if not completely removing below-ground drainage.

Gravity and siphonic roof drainage systems

Advantages of BLÜCHER® roof drainage

All in stainless steel AISI 304 or AISI 316L	Corrosion-resistant, temperature-resistant and impact-resistant Not affected by UV Minimal expansion caused by temperature changes Non-combustible, fire rated A1 Retains its aesthetically pleasing finish, requiring minimal maintenance Robust construction that resists vandalism 100% recyclable
Thin-walled pipes	Light-weight and easy to handle, makes installation fast and easy and provides better working environment Fewer fixing points required due to the low weight of the pipework system Larger inside diameter in combination with the low surface roughness of stainless steel provides up to 30% higher flow capacity compared to similar outside diameter cast-iron pipes
Smooth inside surface	Excellent self-cleansing properties High flow rate Prevents blockages
Push-fit jointing	Fast and easy pipe assembly
Pipe sizes OD 40 - 250 mm and lengths 0,15 - 6 meters	Compact dimensions take up less space Less cutting to size required, thereby less installation costs
Equally suitable for siphonic and gravity	One pipework system fits all applications

BLÜCHER® siphonic roof drainage offers the added advantages of

Only one downpipe to the ground	Less piping necessary Less below-ground work
Fewer roof drains required	Fewer cut-outs in the roof required, thereby lower costs
Small pipe diameters	Light-weight, takes up less space as compared to traditional plastic or cast-iron systems
Pipes approved for -0,85 bar vacuum	Safe solution
Horizontal pipes without fall	Ease of installation

Flow calculations

BLÜCHER offers to carry out flow calculations and suggest design of the roof drainage system for projects with BLÜCHER® Drain Roof and BLÜCHER® EuroPipe.

Enquiries can be submitted through www.blucher.com/projects, or call BLÜCHER at tel. +45 99 92 08 00.

The screenshot displays the BLÜCHER software interface for roof drainage calculations. On the left, there is a navigation menu with options like 'Home', 'Company', 'Products', and 'Support'. The main content area is titled 'BLÜCHER® Roof Drainage System for vacuum and gravity' and includes a brief description of the system's benefits. Below this, there are input fields for 'Project name / number', 'Company', 'Country', 'United Kingdom', and 'Roof 1 info' (including 'Roof type' and 'Roof covering'). A 'Calculate' button is visible at the bottom of the input section.

On the right side of the interface, a detailed drainage network diagram is shown. This diagram illustrates a complex system of pipes and junctions, with various flow rates and pipe diameters indicated. A small table is embedded in the diagram, providing specific data for different sections of the system.

Roof Segment	Roof Area	Roof Slope	Roof Type
1	1000	0.01	Flat
2	1000	0.01	Flat
3	1000	0.01	Flat

At the bottom of the software window, there is a 'FORM OF ORDER' section with fields for 'Customer', 'Customer's location', 'Date', and 'Customer's reference'. The BLÜCHER logo is positioned in the bottom right corner of the interface.

BLÜCHER® Drain Roof

Siphonic drains and gravity drains

BLÜCHER® Drain Roof - siphonic



Owing to the siphonic plate of the drain, the pipe is quickly 100% filled, keeping air out of the system and allowing full bore discharge to induce a siphonic action resulting in higher velocities and greater discharge.

BLÜCHER® Drain Roof - gravity



Traditional gravity drainage system with pipes filled max. 33%.

Both types of drains are available for roofs with bitumen or roofs with single ply roof membrane, shown above are drains for roofs with single ply roof membrane.

BLÜCHER® Drain Roof for bitumen and single ply roof membrane

BLÜCHER® Drain Roof for bitumen



BLÜCHER® Drain Roof for single ply roof membrane

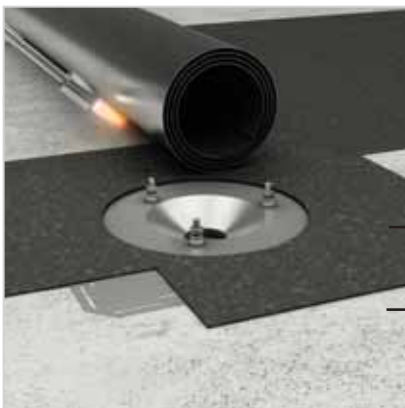

Bitumen
Concrete/insulation

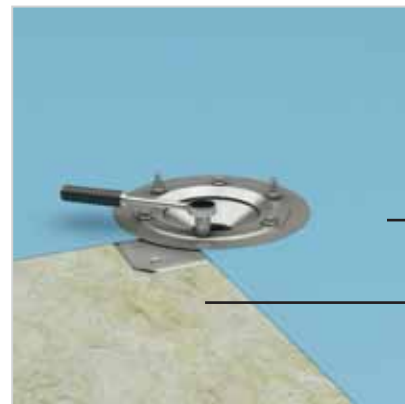

Single ply roof membrane
Concrete/insulation

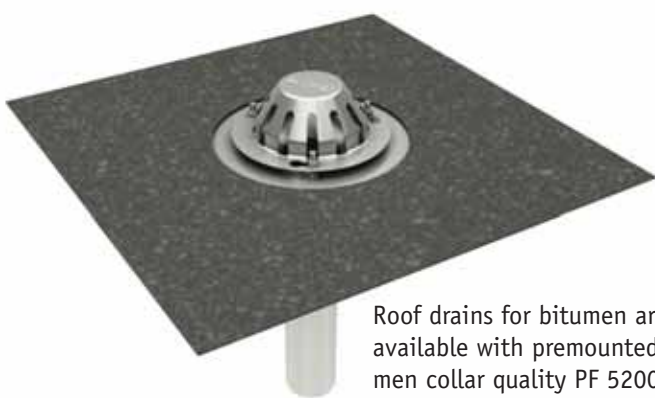

Roof drains for bitumen are also available with premounted bitumen collar quality PF 5200 SBS as recommended by Danish roofing felt information council TOR

Both types of drains are available as siphonic drains and as gravity drains, shown above are siphonic drains.

Where to use BLÜCHER® roof drainage

Gravity

Ideal for roof areas less than 500 m² on traditional buildings such as flat-roofed houses, garages, office buildings, etc.



Private housing



Multi-storey car park, shopping mall Nørreport Centeret, Holstebro, Denmark

Siphonic

The best choice for large roof areas (over 500 m²) such as office buildings, industrial facilities, shopping centres etc.



Postal terminal Berger, Norway

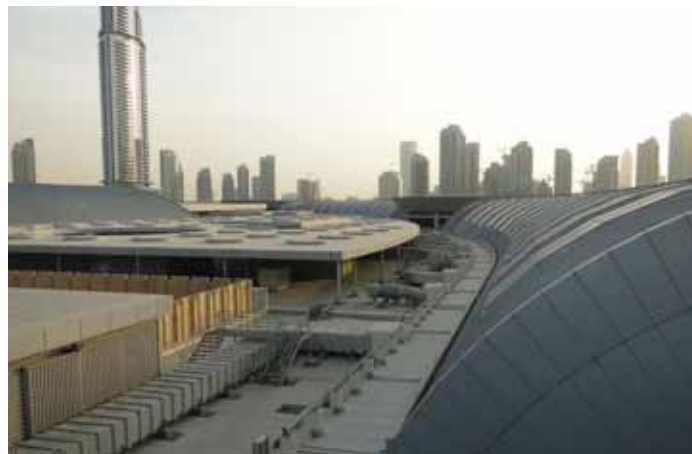

Géant Mall, Dubai, UAE

Applicable standards

EN 1253

BLÜCHER® Drain Roof has been tested by LGA Würzburg and complies with the requirements of EN 1253 1+2. BLÜCHER has its own state-of-the-art laboratory with facilities to design and develop drainage products in accordance with EN 1253. BLÜCHER is committed to offering a thoroughly tested roof drainage system that complies with applicable standards and regulations as to performance and installation.



EN 12056, DS 432 and VDI 3806

BLÜCHER recommends installation in accordance with DS 432/EN 12056 3 and VDI 3806. This ensures that the BLÜCHER® roof drainage system can be used in all common building projects in Europe. VDI 3806 are guidelines for siphonic roof drainage, used as applicable guidelines in the EU.

TOR recommendations

BLÜCHER® roof drainage system complies with the recommendations of TOR (Danish roofing felt information council).

SRDA

Member of SRDA - Siphonic Roof Drainage Association. Comply hereby to BS8490:2007



Accessories

Emergency drainage

All roof drainage systems require emergency drainage to ensure that the roof remains water tight in the event of a rain storm rate in excess of the chosen design storm rate. For roofs with bitumen and for roofs with single ply roof membrane BLÜCHER offers an emergency drainage system to be installed in the same way as the common roof drainage system but with a separate BLÜCHER® EuroPipe downpipe leading water away from the roof.



Thermal insulation

Where there is a need for protecting the roof from condensate, an insulating sleeve can easily be fitted around the drain outlet. For BLÜCHER® Drain Roof we have selected a non-combustible insulation core which performs optimally even at temperatures on the roof below 5 °C, thus minimizing condensation. Optionally, BLÜCHER® Drain Roof can be supplied with the insulating sleeve fitted to the drain outlet.



Trace heating

For installation in areas where ambient temperatures below 0 °C often occur, BLÜCHER offers a heating cable which is to be fitted around the roof drain and then covered by the insulating sleeve. This ensures a frost-free roof drain that will not be blocked by ice. The heating cable has a performance of 14,5 W per meter at an ambient temperature of 0 °C. Optionally, BLÜCHER® Drain Roof can be supplied fitted with heating cable and insulating sleeve.



Installation

BLÜCHER® Drain Roof

Due to the small size of the drain bowl leading the water into the piping system, only a small hole in the roof or the insulation is necessary, and this can be drilled easily and quickly.

Secure the drain to the roof by fixing the flange by means of 4 screws, or optionally secure the drain to the membrane selected for the roof.

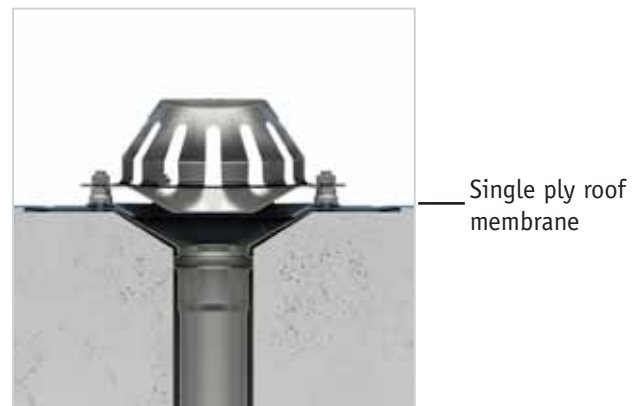

Drain outlet piping

The roof drains come with outlet pipes of either 400 or 600 mm length, and this makes it possible to penetrate the roof insulation without any pipe joints in the insulation. This makes installation fast and safe, and below the insulation BLÜCHER® EuroPipe pipes and fittings can be fitted directly to the outlet piping.

If a shorter outlet pipe is requested, the outlet pipes can be cut to the desired length on site. For this purpose we recommend the BLÜCHER® pipe cutter, available as manual or electrical pipe cutter.

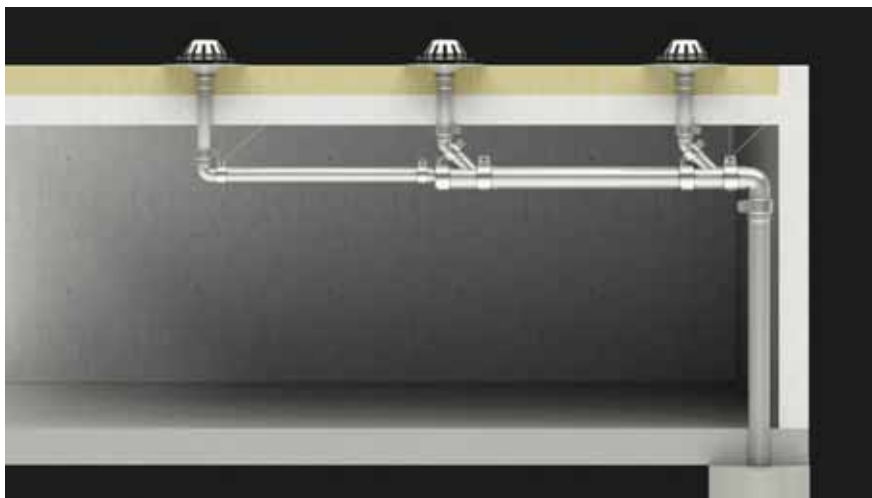

Installation

BLÜCHER® EuroPipe

BLÜCHER® EuroPipe stainless steel drainage pipework system is a light-weight push-fit piping system comparable to plastic pipework systems in weight and to cast-iron pipework systems in strength.

Pipes are available in OD40 - OD250 mm in lengths ranging from 15 cm to 6 m. In addition, the pipes can be cut to the desired length on site. For this purpose we recommend the BLÜCHER® pipe cutter, available as manual or electrical pipe cutter.

The pipes are completely interchangeable between gravity or siphonic systems without requiring change of sealing ring.

One man alone can easily install the pipes below roof. Push-fit jointing and easy cutting to length on site make installation fast and simple, and fixing the pipes requires only a simple locking mechanism with pipe joint clamps with no need for a rack system or similar.

Considering the whole-life costs of the pipework system, BLÜCHER® EuroPipe is the most cost-efficient choice, offering approximately 40% saving on installation time as compared to cast-iron pipework systems as stated in BSRIA data sheet 5.11.2

Being non-combustible and not damaged by impacts as opposed to plastic pipework systems, BLÜCHER® EuroPipe offers lower whole-life costs as stated in Building Performance Group Ltd. assessment report no. 1732.

Suspension and fixing of pipework

The following describes the fixing of pipes for vertical and horizontal pipe runs.

Vertical piping

All vertical pipework should be provided with pipe brackets at intervals not exceeding 3 metres. Brackets to be placed under ring seal sockets whenever possible.

Horizontal piping

All horizontal pipework should be provided with pipe brackets at intervals not exceeding 3 metres. Brackets to be placed under ring seal sockets whenever possible.

Additional brackets are required at each change of direction, i.e. bends and branches, to anchor the installation to the structure. If it is impractical to anchor to the structure, then hanging and raking fixings 847.000.000 along with joint clamps 847.xxx.xxx must be fitted to prevent movement.

If it is impractical to install hanging and raking fixings on a particular change of direction, then joint clamps 847.xxx.xxx can be used on all joints along the straight run or runs affected by the lack of restraint. Socket plugs type 844 need joint clamps type 847 to withstand internal pressure from a possible blockage.



Siphonic installation

We recommend the use of pipe joint clamps at each bend or bracket and the use of the BLÜCHER® mounting plate for suspension of the drainage pipework for each 3 metres. This will safeguard the pipework system against vibrations and keep the pipes in place in siphonic roof drainage installations.

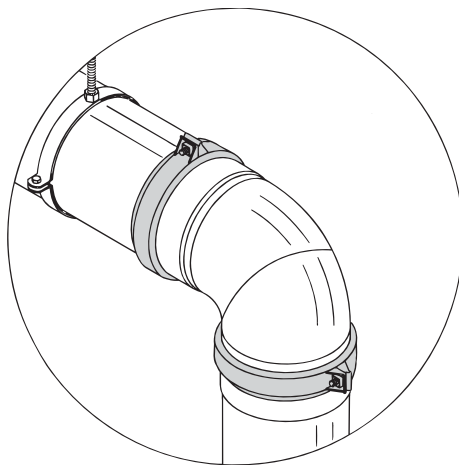

Pipe joint clamps type no. 847.
xxx.xxx may be required if walls
or soffits are not accessible for
brackets.

Emergency drains

All pipework to be installed in the same way as in vacuum systems, i.e. with pipe joint clamps at each bend or bracket.

Auxiliary products to BLÜCHER® roof drainage system

Balcony drains

Stainless steel balcony drains with low built-in height, long product-life expectancy and aesthetically pleasing design for your balcony.



183.101.0XX



183.151.XXX



182.105.032

Outdoor drain

Stainless steel drain used in roof gardens and around terraces placed above a below-ground garage. Comes with OD110 mm vertical outlet, flange for membrane and adjustable upper part 200x200 or 300x300 mm. Sand bucket and a range of gratings are available.

The outdoor drain has a perforated pipe between frame and lower part to enable drainage from the sand/gravel in which the drain is installed and into the lower part.



Outdoor rainwater piping



All BLÜCHER® EuroPipe rainwater downpipes are vandal-resistant, combining the aesthetically pleasing look of stainless steel with vandal-proofing of the downpiping and the other inherent benefits of stainless steel material.

For details on auxiliary products please contact BLÜCHER, tel. +45 99920800 or mail@blucher.com.

Auxiliary products to BLÜCHER® roof drainage system

Channels

Stainless steel drainage channel system suitable as gutter around a defined area, in front of doors to prevent water flowing in through the door and to collect the water to be drained off the roof area.



Industrial drains with gratings for high weight loads

For use for instance in multi-storey car parks, BLÜCHER offers BLÜCHER® Drain Industrial heavy-duty floor drains that can be fitted with a range of gratings suitable for weight loads up to 8400 kg (load class M) depending on the type of grating.



For details on auxiliary products please contact BLÜCHER, tel. +45 99920800 or mail@blucher.com.

Installation examples



Easy and simple installation in single ply roof membrane provides high strength and a secure solution.



Roof drains for bitumen have a wide collar for secure fixing to the bitumen.



2-part roof drain

2-part roof drains can easily be installed on the roof. Use a standard roof drain in combination with a separate lower part matching the membrane type of the roof.

References

- Blackfriars Station, London BLÜCHER® Drain, BLÜCHER® EuroPipe
- Mail terminal Postens Terminal Berger, Norway BLÜCHER® EuroPipe
- Dairy Tine Meierier Vest, Norway BLÜCHER® EuroPipe
- Cultural Centre Bømlo Kulturhus, Norway BLÜCHER® EuroPipe
- Continental Dekk Askim, Norway BLÜCHER® EuroPipe
- Arora Hotel Gatwick Crawley, UK BLÜCHER® EuroPipe
- Apartments Ballymun, Ireland BLÜCHER® EuroPipe
- Docklands Light Railway London, UK BLÜCHER® EuroPipe
- Dublin Airport T2, Ireland BLÜCHER® EuroPipe
- Golden Square Shopping Centre Warrington, UK BLÜCHER® EuroPipe
- Trafford Shopping Centre Manchester, UK BLÜCHER® EuroPipe
- Main Station Salzburg, Austria BLÜCHER® EuroPipe
- Dubai Mall, UAE BLÜCHER® Drain, BLÜCHER® EuroPipe
- Hilton Resort, Ras Al Khaimah BLÜCHER® Drain, BLÜCHER® EuroPipe
- New Doha International Airport, Qatar BLÜCHER® EuroPipe
- Bank of Greece, Thessaloniki, Greece BLÜCHER® EuroPipe



for gravity

ROOF DRAIN TYPE 401.10

WITH FLANGE FOR BITUMEN

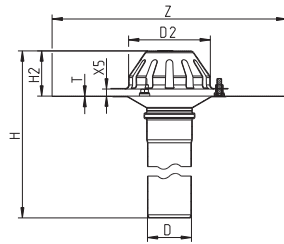

Type no.	EAN no.	D	Z	H	H2	D2	X5	T
401.104.050	5705499132731	50	400x400	495	77	140	12	0.7
401.104.075	5705499132748	75	400x400	495	77	140	12	0.7
401.104.110	5705499132755	110	400x400	495	77	140	12	0.7

Flow rate in accordance with "Flow rates for roof drains"

ROOF DRAIN TYPE 402.10

WITH CLAMPING FLANGE FOR SINGLE PLY MEMBRANE

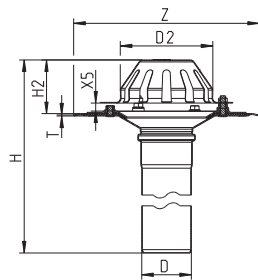

Type no.	EAN no.	D	Z	H	H2	D2	X5	T
402.104.050	5705499132762	50	280x280	501	81	140	12	1.5
402.104.075	5705499132779	75	280x280	501	81	140	12	1.5
402.104.110	5705499132786	110	280x280	501	81	140	12	1.5
402.106.050	5705499132793	50	280x280	701	81	140	12	1.5
402.106.075	5705499132809	75	280x280	701	81	140	12	1.5
402.106.110	5705499132816	110	280x280	701	81	140	12	1.5

Flow rate in accordance with "Flow rates for roof drains"

for gravity

ROOF DRAIN TYPE 403.10

WITH FLANGE FOR BITUMEN AND PRE-MOUNTED BITUMEN COLLAR

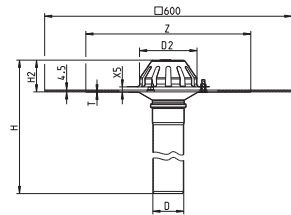
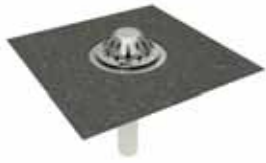

Type no.	EAN no.	D	Z	H	H2	D2	X5	T
403.104.050	5705499133141	50	400x400	495	77	140	12	0.7
403.104.075	5705499133158	75	400x400	495	77	140	12	0.7
403.104.110	5705499133165	110	400x400	495	77	140	12	0.7

Flow rate in accordance with "Flow rates for roof drains"

for siphonic

ROOF DRAIN TYPE 401.20

WITH FLANGE FOR BITUMEN

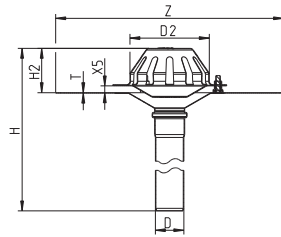

Type no.	EAN no.	D	Z	H	H2	D2	X5	T
401.204.040	5705499132823	40	400x400	496	78	140	12	0.7
401.204.050	5705499132830	50	400x400	496	78	140	12	0.7
401.204.075	5705499132847	75	400x400	496	78	140	12	0.7

Flow rate in accordance with "Flow rates for roof drains"

ROOF DRAIN TYPE 402.20

WITH CLAMPING FLANGE FOR SINGLE PLY MEMBRANE

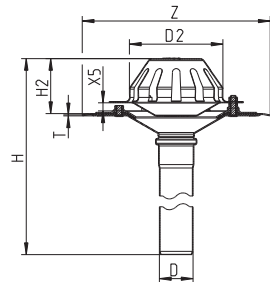

Type no.	EAN no.	D	Z	H	H2	D2	X5	T
402.204.040	5705499132854	40	280x280	502	82	140	12	1.5
402.204.050	5705499132861	50	280x280	502	82	140	12	1.5
402.204.075	5705499132878	75	280x280	502	82	140	12	1.5
402.206.040	5705499132885	40	280x280	702	82	140	12	1.5
402.206.050	5705499132892	50	280x280	702	82	140	12	1.5
402.206.075	5705499132908	75	280x280	702	82	140	12	1.5

Flow rate in accordance with "Flow rates for roof drains"

for siphonic

ROOF DRAIN TYPE 403.20

WITH FLANGE FOR BITUMEN AND PRE-MOUNTED BITUMEN COLLAR

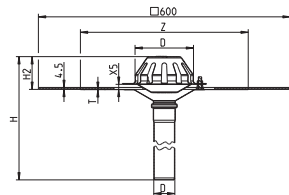
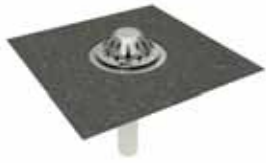

Type no.	EAN no.	D	Z	H	H2	D2	X5	T
403.204.040	5705499133172	40	400x400	496	78	140	12	0.7
403.204.050	5705499133189	50	400x400	496	78	140	12	0.7
403.204.075	5705499133196	75	400x400	496	78	140	12	0.7

Flow rate in accordance with "Flow rates for roof drains"

LOWER PART FOR ROOF DRAIN TYPE 401.00

WITH FLANGE FOR BITUMEN

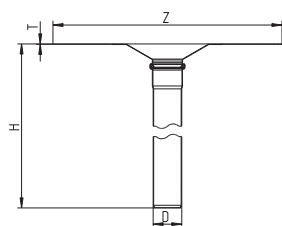

Type no.	EAN no.	D	Z	H	T
401.004.040	5705499132915	40	400x400	418	0.7
401.004.050	5705499132922	50	400x400	418	0.7
401.004.075	5705499132939	75	400x400	418	0.7
401.004.110	5705499132946	110	400x400	418	0.7

LOWER PART FOR ROOF DRAIN TYPE 402.00

WITH CLAMPING FLANGE FOR SINGLE PLY MEMBRANE

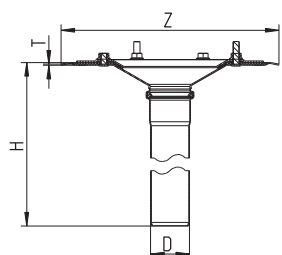

Type no.	EAN no.	D	Z	H	T
402.004.040	5705499132953	40	280x280	420	1.5
402.004.050	5705499132960	50	280x280	420	1.5
402.004.075	5705499132977	75	280x280	420	1.5
402.004.110	5705499132984	110	280x280	420	1.5

EMERGENCY DRAIN STAND PIPE TYPE 400.100

FOR ROOF WITH GRAVITY DRAINAGE

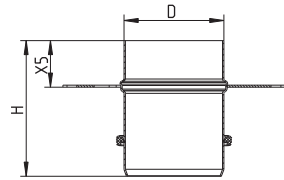

Type no.	EAN no.	D	H	X5	Max Flow (l/s)
400.100.050	5705499132991	50	105	35	6.2
400.100.075	5705499133004	75	102	35	11.5
400.100.110	5705499133011	110	107	35	9.7

Flow rate measured 35mm above top of pipe (70mm above surface of roof)

EMERGENCY DRAIN STAND PIPE TYPE 400.200

FOR ROOF WITH SIPHONIC DRAINAGE

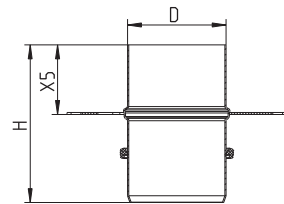

Type no.	EAN no.	D	H	X5	Max Flow (l/s)
400.200.050	5705499133028	50	123	55	6.1
400.200.075	5705499133035	75	120	55	12.8

Flow rate measured 35mm above top of pipe (90mm above surface of roof)

ROOF DRAIN INSULATION TYPE 400.001

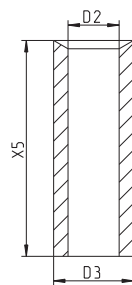

Type no.	EAN no.	D2	D3	X5
400.001.040	5705499133059	45	86	330
400.001.050	5705499133066	56	98	330
400.001.075	5705499133073	78	122	330
400.001.110	5705499133080	118	165	330

ELECTRICAL HEATING CABLE

0,8M HEATING CABLE + 1,0M RUBBER CABLE



Type no.	EAN no.
400.000.000	5705499133042

SIPHONIC PLATE

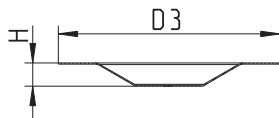

Type no.	EAN no.	H	D3
400.000.100	5705499133110	21	200

LEAF GUARD TYPE 400.000.001

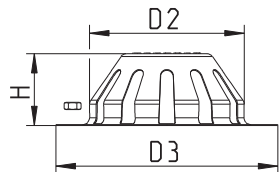

Type no.	EAN no.	H	D2	D3
400.000.001	5705499133127	65	140	200

LEAF GUARD TYPE 400.000.002

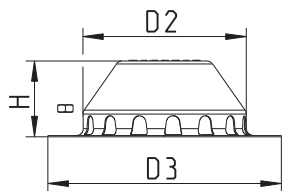

Type no.	EAN no.	H	D2	D3
400.000.002	5705499133134	65	140	200

By using this leaf guard in gravity systems, flow can be doubled. Need for more frequent cleaning to be expected.

SET OF NUTS FOR ROOF DRAIN



Type no.

EAN no.

400.000.003

5705499133202

Flow rates for pipe dimension OD40 mm

BLÜCHER® Drain Roof - siphonic OD40 mm

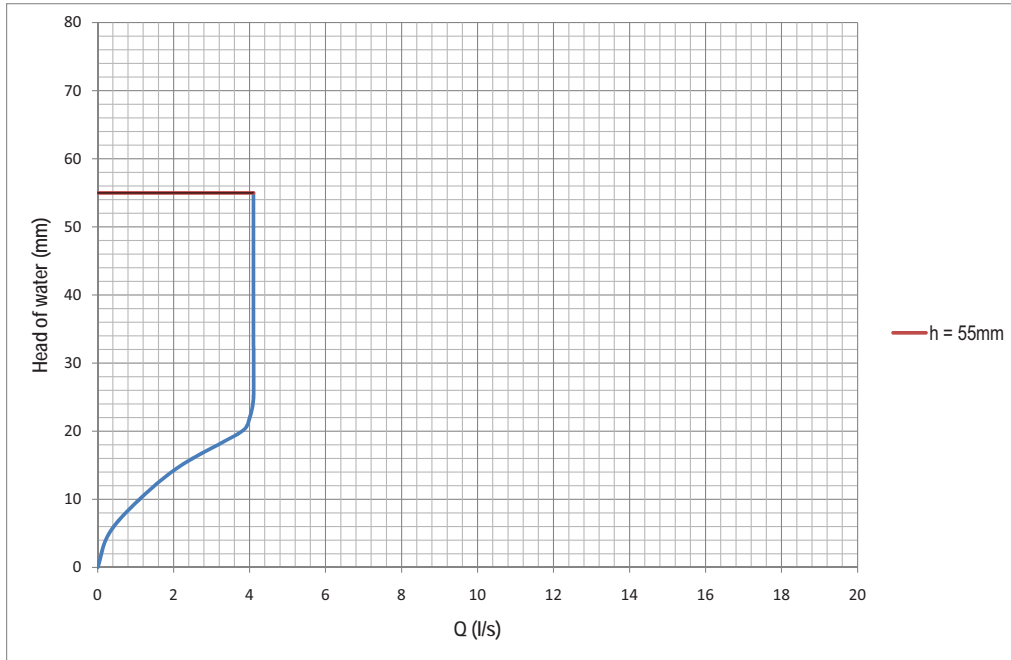

Test information and basis

Flow test carried out at TÜV Rheinland LGA Products GmbH February 2011.

Siphonic flow tested in accordance with EN1253 1+2 and carried out according to 1253-2: 2003 page 16 Figure 8D

Gravity flow tested in accordance with EN1253 1+2 and carried out according to 1253-2: 2003 page 16 Figure 8C

Flow rates for pipe dimension OD50 mm

BLÜCHER® Drain Roof - siphonic OD50 mm

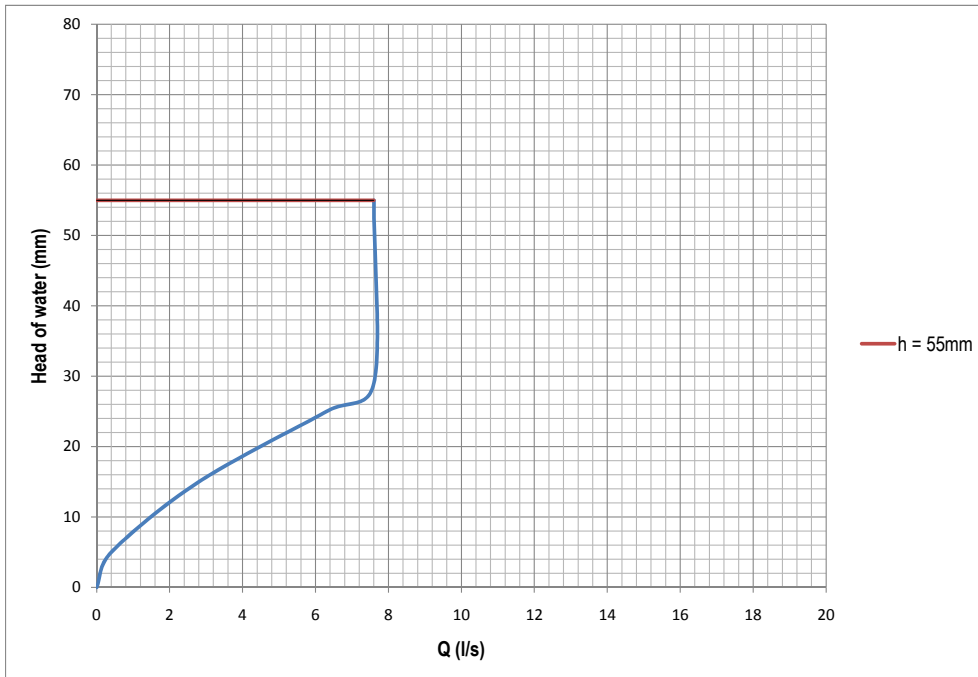

BLÜCHER® Drain Roof - gravity OD50 mm

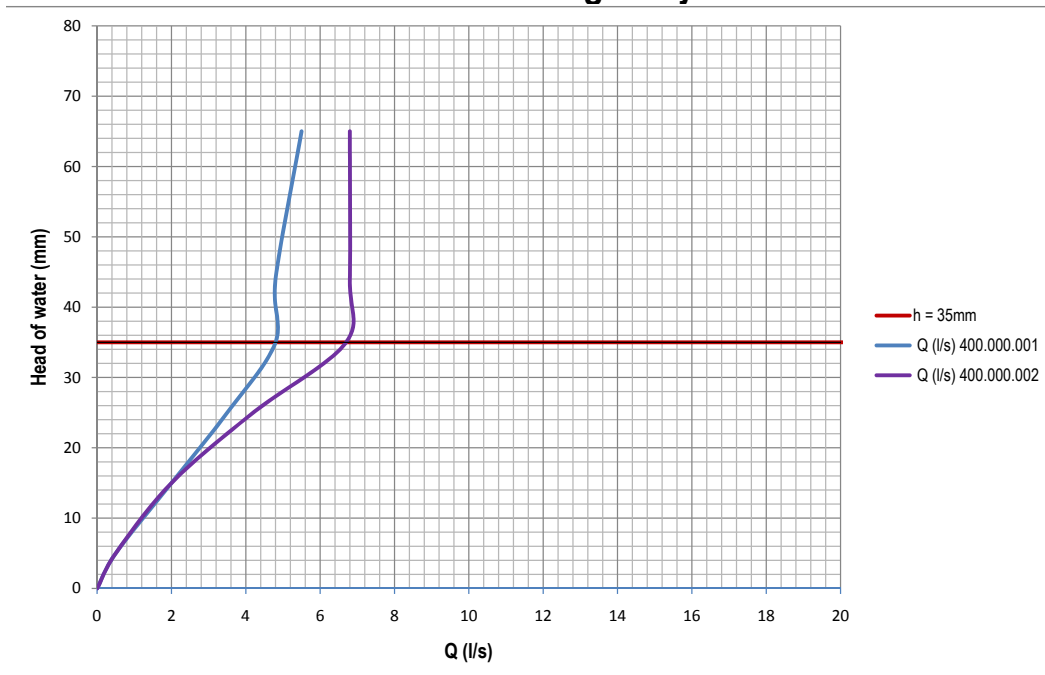

Test information and basis

Flow test carried out at TÜV Rheinland LGA Products GmbH February 2011.

Siphonic flow tested in accordance with EN1253 1+2 and carried out according to 1253-2: 2003 page 16 Figure 8D

Gravity flow tested in accordance with EN1253 1+2 and carried out according to 1253-2: 2003 page 16 Figure 8C

Flow rates for pipe dimension OD75 mm

BLÜCHER® Drain Roof - siphonic OD75 mm

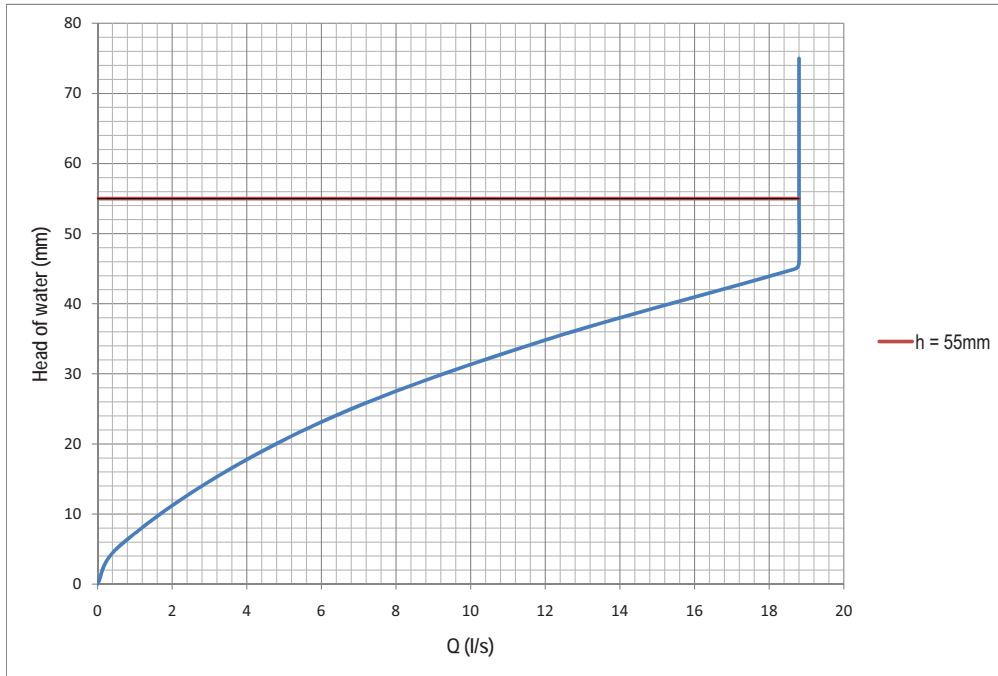

BLÜCHER® Drain Roof - gravity OD75 mm

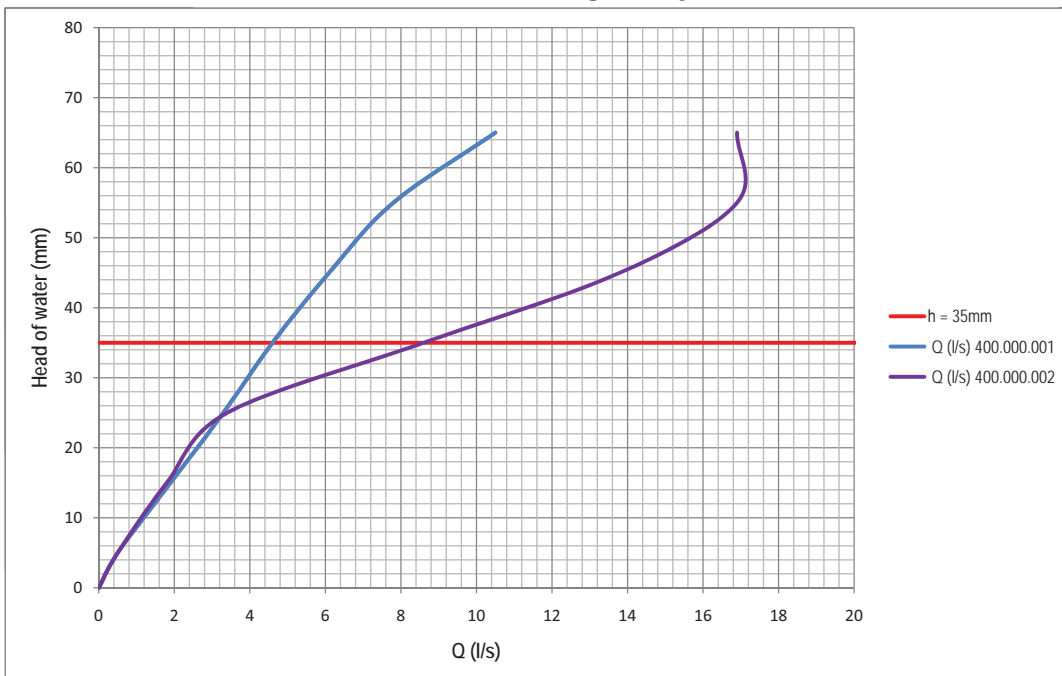

Test information and basis

Flow test carried out at TÜV Rheinland LGA Products GmbH February 2011.

Siphonic flow tested in accordance with EN1253 1+2 and carried out according to 1253-2: 2003 page 16 Figure 8D

Gravity flow tested in accordance with EN1253 1+2 and carried out according to 1253-2: 2003 page 16 Figure 8C

Flow rates for pipe dimension OD110 mm

BLÜCHER® Drain Roof - gravity OD110 mm

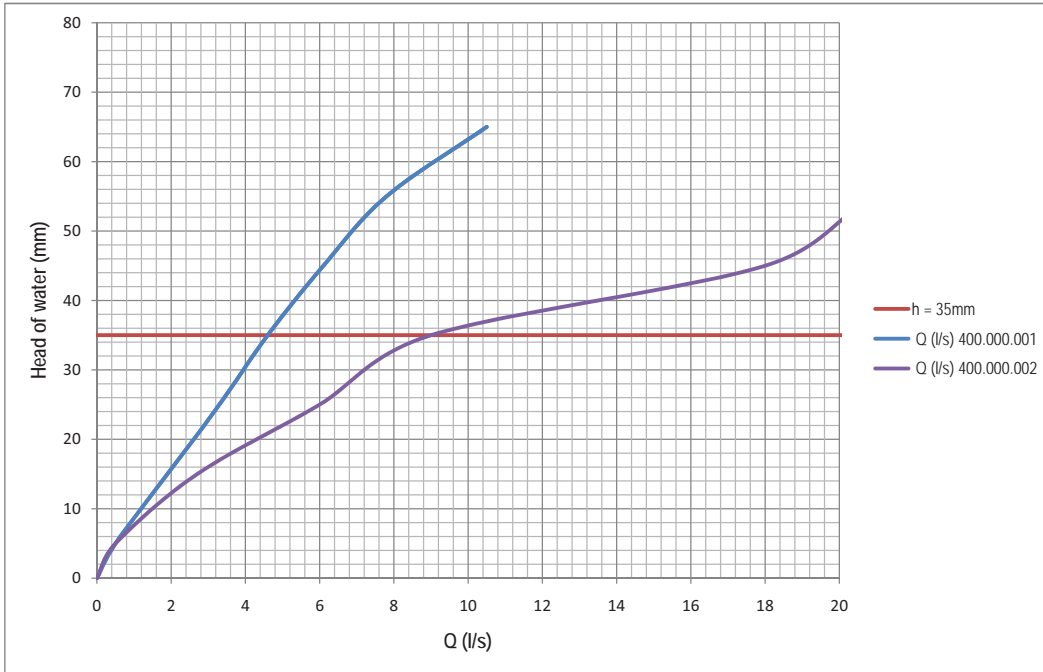

Test information and basis

Flow test carried out at TÜV Rheinland LGA Products GmbH February 2011.

Siphonic flow tested in accordance with EN1253 1+2 and carried out according to 1253-2: 2003 page 16 Figure 8D

Gravity flow tested in accordance with EN1253 1+2 and carried out according to 1253-2: 2003 page 16 Figure 8C

DIMENSIONAL DRAWING, SOCKET AND SPIGOT END

PIPES AND FITTINGS

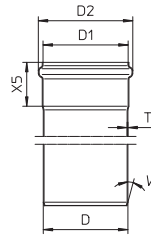

Type no.	EAN no.	D	D1	D2	X5	T	V
811.XXX.040		40	41	52	41	1	20
811.XXX.050		50	51	61	42	1	20
811.XXX.075		75	76	87	50	1	20
811.XXX.082		82	83	94	52	1	20
811.XXX.110		110	111	123	57	1	20
811.XXX.125		125	126	140	60	1	20
811.XXX.160		160	161	177	72	1.25	20
811.XXX.200		200	201	219	90	1.5	20
811.XXX.250		250	251	277	108	1.5	20

STRAIGHT PIPE WITH ONE SOCKET TYPE 811

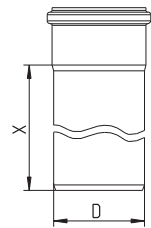

Type no.	EAN no.	D	X	Kg
811.015.040	5705499412635	40	150	0,20
811.015.040 S	5705499412642	40	150	0,20
811.025.040	5705499412659	40	250	0,29
811.025.040 S	5705499412666	40	250	0,29
811.050.040	5705499412673	40	500	0,68
811.050.040 S	5705499412680	40	500	0,00
811.075.040	5705499412697	40	750	0,78
811.075.040 S	5705499412703	40	750	0,78
811.100.040	5705499412710	40	1000	1,02
811.100.040 S	5705499412727	40	1000	1,02
811.150.040	5705499412734	40	1500	1,50
811.150.040 S	5705499412741	40	1500	1,50
811.200.040	5705499412758	40	2000	1,99
811.200.040 S	5705499412765	40	2000	1,99
811.300.040	5705499412772	40	3000	2,96
811.300.040 S	5705499412789	40	3000	2,96
811.400.040	5705499412796	40	4000	3,92
811.400.040 S	5705499412802	40	4000	3,92
811.500.040	5705499412819	40	5000	4,89
811.500.040 S	5705499412826	40	5000	4,89
811.600.040	5705499412833	40	6000	5,86
811.600.040 S	5705499412840	40	6000	5,86

811.015.050	5705499400205	50	150	0,25
811.015.050 S	5705499400212	50	150	0,25
811.025.050	5705499400281	50	250	0,38
811.025.050 S	5705499400298	50	250	0,38
811.050.050	5705499400366	50	500	0,68
811.050.050 S	5705499400373	50	500	0,68
811.075.050	5705499400441	50	750	1,00
811.075.050 S	5705499400458	50	750	1,00
811.100.050	5705499400526	50	1000	1,25
811.100.050 S	5705499400533	50	1000	1,25
811.150.050	5705499400601	50	1500	1,90
811.150.050 S	5705499400618	50	1500	1,90
811.200.050	5705499400687	50	2000	2,45
811.200.050 S	5705499400694	50	2000	2,45
811.300.050	5705499400762	50	3000	3,82
811.300.050 S	5705499400786	50	3000	3,82
811.400.050	5705499400854	50	4000	5,06
811.400.050 S	5705499400861	50	4000	5,06
811.500.050	5705499400939	50	5000	6,31
811.500.050 S	5705499400946	50	5000	6,31
811.600.050	5705499401011	50	6000	7,56
811.600.050 S	5705499401028	50	6000	7,56

811.015.075	5705499400229	75	150	0,41
811.015.075 S	5705499400236	75	150	0,41
811.025.075	5705499400304	75	250	0,58
811.025.075 S	5705499400311	75	250	0,58
811.050.075	5705499400380	75	500	1,00
811.050.075 S	5705499400397	75	500	1,00
811.075.075	5705499400465	75	750	1,50
811.075.075 S	5705499400472	75	750	1,50
811.100.075	5705499400540	75	1000	1,95

Continues on next page

STRAIGHT PIPE WITH ONE SOCKET TYPE 811

Type no.	EAN no.	D	X	Kg
Continued from previous page				
811.100.075 S	5705499400557	75	1000	1,95
811.150.075	5705499400625	75	1500	2,75
811.150.075 S	5705499400632	75	1500	2,75
811.200.075	5705499400700	75	2000	3,70
811.200.075 S	5705499400717	75	2000	3,70
811.300.075	5705499400793	75	3000	5,78
811.300.075 S	5705499400809	75	3000	5,78
811.400.075	5705499400878	75	4000	7,66
811.400.075 S	5705499400885	75	4000	7,66
811.500.075	5705499400953	75	5000	9,54
811.500.075 S	5705499400960	75	5000	9,54
811.600.075	5705499401035	75	6000	11,42
811.600.075 S	5705499401042	75	6000	11,42
-----	-----	-----	-----	-----
811.015.082	5705499411591	82	150	0,44
811.015.082 S	5705499411607	82	150	0,44
811.025.082	5705499411614	82	250	0,64
811.025.082 S	5705499411621	82	250	0,64
811.050.082	5705499411638	82	500	1,14
811.050.082 S	5705499411645	82	500	1,14
811.075.082	5705499411652	82	750	1,65
811.075.082 S	5705499411669	82	750	1,65
811.100.082	5705499411676	82	1000	2,15
811.100.082 S	5705499411683	82	1000	2,15
811.150.082	5705499411690	82	1500	3,16
811.150.082 S	5705499411706	82	1500	3,16
811.200.082	5705499411713	82	2000	4,17
811.200.082 S	5705499411720	82	2000	4,17
811.300.082	5705499411737	82	3000	6,20
811.300.082 S	5705499411744	82	3000	6,20
811.400.082	5705499411751	82	4000	8,22
811.400.082 S	5705499411768	82	4000	8,22
811.500.082	5705499411775	82	5000	10,24
811.500.082 S	5705499411782	82	5000	10,24
811.600.082	5705499411799	82	6000	12,26
811.600.082 S	5705499411805	82	6000	12,26
-----	-----	-----	-----	-----
811.015.110	5705499400243	110	150	0,61
811.015.110 S	5705499400250	110	150	0,61
811.025.110	5705499400328	110	250	0,87
811.025.110 S	5705499400335	110	250	0,87
811.050.110	5705499400403	110	500	1,50
811.050.110 S	5705499400410	110	500	1,50
811.075.110	5705499400489	110	750	2,15
811.075.110 S	5705499400496	110	750	2,15
811.100.110	5705499400564	110	1000	2,85
811.100.110 S	5705499400571	110	1000	2,85
811.150.110	5705499400649	110	1500	4,30
811.150.110 S	5705499400656	110	1500	4,30
811.200.110	5705499400724	110	2000	5,40
811.200.110 S	5705499400731	110	2000	5,40
811.300.110	5705499400816	110	3000	8,34
811.300.110 S	5705499400823	110	3000	8,50
811.400.110	5705499400892	110	4000	11,26
811.400.110 S	5705499400908	110	4000	11,26
811.500.110	5705499400977	110	5000	14,02
811.500.110 S	5705499400984	110	5000	14,00
811.600.110	5705499401059	110	6000	16,78
811.600.110 S	5705499401066	110	6000	16,78
-----	-----	-----	-----	-----
811.015.125	5705499410839	125	150	0,70
811.015.125 S	5705499410846	125	150	0,70
811.025.125	5705499408218	125	250	1,01
811.025.125 S	5705499408225	125	250	1,01
811.050.125	5705499408232	125	500	1,78
811.050.125 S	5705499408249	125	500	1,78
811.075.125	5705499410860	125	750	2,55
811.075.125 S	5705499408256	125	750	2,55
811.100.125	5705499408263	125	1000	3,32
811.100.125 S	5705499408270	125	1000	3,32
811.150.125	5705499408287	125	1500	4,86
811.150.125 S	5705499408294	125	1500	4,86
Continues on next page				

STRAIGHT PIPE WITH ONE SOCKET TYPE 811

Type no.	EAN no.	D	X	Kg
Continued from previous page				
811.200.125	5705499408300	125	2000	6,40
811.200.125 S	5705499408317	125	2000	6,40
811.300.125	5705499410907	125	3000	9,47
811.300.125 S	5705499408324	125	3000	9,47
811.400.125	5705499410914	125	4000	12,55
811.400.125 S	5705499410921	125	4000	12,55
811.500.125	5705499410938	125	5000	15,63
811.500.125 S	5705499410945	125	5000	15,63
811.600.125	5705499410952	125	6000	18,71
811.600.125 S	5705499410969	125	6000	18,71
-----	-----	-----	-----	-----
811.015.160	5705499400267	160	150	1,19
811.015.160 S	5705499400274	160	150	1,19
811.025.160	5705499400342	160	250	1,69
811.025.160 S	5705499400359	160	250	1,69
811.050.160	5705499400427	160	500	2,96
811.050.160 S	5705499400434	160	500	2,96
811.075.160	5705499400502	160	750	4,22
811.075.160 S	5705499400519	160	750	4,22
811.100.160	5705499400588	160	1000	5,48
811.100.160 S	5705499400595	160	1000	5,48
811.150.160	5705499400663	160	1500	8,02
811.150.160 S	5705499400670	160	1500	8,02
811.200.160	5705499400748	160	2000	10,54
811.200.160 S	5705499400755	160	2000	10,54
811.300.160	5705499400830	160	3000	15,59
811.300.160 S	5705499400847	160	3000	15,59
811.400.160	5705499400915	160	4000	20,64
811.400.160 S	5705499400922	160	4000	20,64
811.500.160	5705499400991	160	5000	25,69
811.500.160 S	5705499401004	160	5000	25,69
811.600.160	5705499401073	160	6000	30,74
811.600.160 S	5705499401080	160	6000	30,74
-----	-----	-----	-----	-----
811.015.200	5705499412291	200	150	1,96
811.015.200 S	5705499411522	200	150	1,96
811.025.200	5705499412307	200	250	2,77
811.025.200 S	5705499411539	200	250	2,77
811.050.200	5705499412314	200	500	4,62
811.050.200 S	5705499410853	200	500	4,62
811.075.200	5705499412321	200	750	6,47
811.075.200 S	5705499411546	200	750	6,47
811.100.200	5705499412338	200	1000	8,32
811.100.200 S	5705499410877	200	1000	8,32
811.200.200	5705499412345	200	2000	15,71
811.200.200 S	5705499410884	200	2000	15,71
811.300.200	5705499412352	200	3000	23,10
811.300.200 S	5705499410891	200	3000	23,10
-----	-----	-----	-----	-----
811.050.250	5705499121735	250	500	5,84
811.050.250 S	5705499121551	250	500	5,84
811.100.250	5705499121742	250	1000	10,47
811.100.250 S	5705499121568	250	1000	10,47
811.200.250	5705499121759	250	2000	19,72
811.200.250 S	5705499121575	250	2000	19,72
811.300.250	5705499121766	250	3000	28,97
811.300.250 S	5705499121582	250	3000	28,97

- Bends

BEND 15° TYPE 820.015

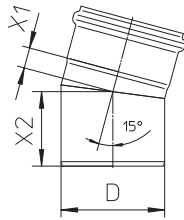

Type no.	EAN no.	D	X1	X2	Kg
820.015.040	5705499412857	40	15	53	0,12
820.015.040 S	5705499412864	40	15	53	0,12
820.015.050	5705499401127	50	19	53	0,15
820.015.050 S	5705499401134	50	19	53	0,15
820.015.075	5705499401141	75	21	65	0,28
820.015.075 S	5705499401158	75	21	65	0,28
820.015.082	5705499411812	82	17	64	0,30
820.015.082 S	5705499411829	82	17	64	0,30
820.015.110	5705499401165	110	25	78	0,47
820.015.110 S	5705499401172	110	25	78	0,47
820.015.125	5705499408607	125	19	84	0,56
820.015.125 S	5705499408614	125	19	84	0,56
820.015.160	5705499401189	160	29	99	1,08
820.015.160 S	5705499401196	160	29	99	1,08
820.015.200 S	5705499410976	200	31	123	1,99
820.015.250 S	5705499121599	250	38	136	3,03

BEND 30° TYPE 820.030

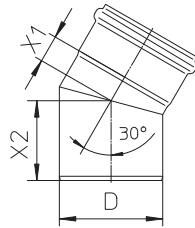

Type no.	EAN no.	D	X1	X2	Kg
820.030.040	5705499412871	40	18	55	0,13
820.030.040 S	5705499412888	40	18	55	0,13
820.030.050	5705499401226	50	23	57	0,16
820.030.050 S	5705499401233	50	23	57	0,16
820.030.075	5705499401240	75	25	70	0,28
820.030.075 S	5705499401257	75	25	70	0,28
820.030.082	5705499411836	82	23	70	0,32
820.030.082 S	5705499411843	82	23	70	0,32
820.030.110	5705499401264	110	33	86	0,51
820.030.110 S	5705499401271	110	33	86	0,51
820.030.125	5705499408652	125	28	98	0,63
820.030.125 S	5705499408669	125	28	98	0,63
820.030.160	5705499401288	160	40	110	1,19
820.030.160 S	5705499401295	160	40	110	1,15
820.030.200 S	5705499410983	200	45	137	2,20
820.030.250 S	5705499121605	250	56	153	3,35

BEND 45° TYPE 820.045

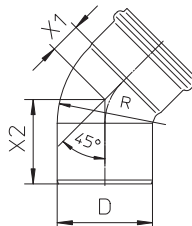

Type no.	EAN no.	D	X1	X2	R	Kg
820.045.040	5705499412895	40	21	58	40	0,13
820.045.040 S	5705499412901	40	21	58	40	0,13
820.045.050	5705499401301	50	27	60	50	0,17
820.045.050 S	5705499401318	50	27	60	50	0,17
820.045.075	5705499401325	75	34	76	75	0,30
820.045.075 S	5705499401332	75	34	76	75	0,30
820.045.082	5705499411850	82	30	80	82	0,34
820.045.082 S	5705499411867	82	30	80	82	0,34
820.045.110	5705499401349	110	43	93	110	0,56
820.045.110 S	5705499401356	110	43	93	110	0,56
820.045.125	5705499408676	125	58	111	125	0,73
820.045.125 S	5705499408683	125	58	111	125	0,73
820.045.160	5705499401363	160	57	128	172	1,55
820.045.160 S	5705499401370	160	57	128	172	1,55

- Bends

BEND, LARGE RADIUS 45° TYPE 820.045

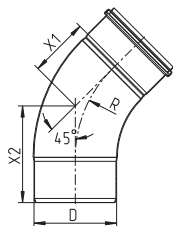

Type no.	EAN no.	D	X1	X2	R	Kg
820.045.200 S	5705499410990	200	144	234	300	4,18
820.045.250 S	5705499121612	250	184	280	375	6,53

BEND 68° TYPE 820.068

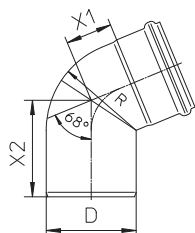

Type no.	EAN no.	D	X1	X2	R	Kg
820.068.082	5705499412369	82	41	97	82	0,40
820.068.082 S	5705499412376	82	41	97	82	0,40
820.068.110	5705499403817	110	57	118	110	0,60
820.068.110 S	5705499404043	110	57	118	110	0,60

BEND 87.5° TYPE 820.090

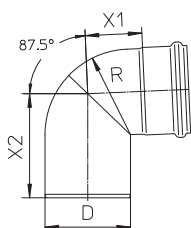

Type no.	EAN no.	D	X1	X2	R	Kg
820.090.040	5705499412918	40	32	79	40	0,16
820.090.040 S	5705499412925	40	32	79	40	0,16
820.090.050	5705499401387	50	41	87	50	0,21
820.090.050 S	5705499401394	50	41	87	50	0,21
820.090.075	5705499401400	75	54	108	75	0,39
820.090.075 S	5705499401417	75	54	108	75	0,39
820.090.082	5705499411874	82	53	109	82	0,43
820.090.082 S	5705499411881	82	53	109	82	0,43
820.090.110	5705499401424	110	74	136	110	0,67
820.090.110 S	5705499401431	110	74	136	110	0,67
820.090.125	5705499408720	125	93	161	125	1,68
820.090.125 S	5705499408737	125	93	161	125	1,68
820.090.160	5705499401448	160	103	184	171	2,10
820.090.160 S	5705499401455	160	103	184	171	2,10

To comply with BS EN 12056 Gravity Drainage inside Buildings use 821 bend at offsets and base of stack.

BEND, LARGE RADIUS 87.5° TYPE 820.090

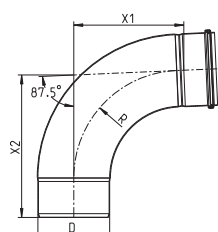

Type no.	EAN no.	D	X1	X2	R	Kg
820.090.200 S	5705499411423	200	307	397	300	6,41
820.090.250 S	5705499121629	250	388	484	375	9,88

To comply with BS EN 12056 Gravity Drainage inside Buildings use 821 bend at offsets and base of stack.

- Bends

BEND, LONG RADIUS 87.5°, 50 MM TYPE 821.000

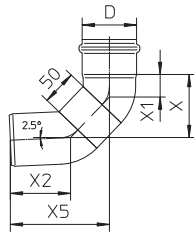

Type no.	EAN no.	D	X	X1	X2	X5	Kg
821.000.050	5705499404005	50	77	26	72	120	0,30
821.000.050 S	5705499404012	50	77	26	72	120	0,30
821.000.075	5705499404029	75	90	32	86	141	0,50
821.000.075 S	5705499404036	75	90	32	86	141	0,50

BEND, LONG RADIUS 87.5°, 164 MM TYPE 821.164

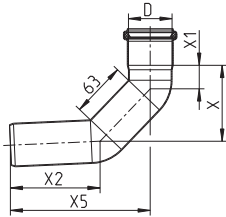

Type no.	EAN no.	D	X	X1	X2	X5
821.164.050	5705499123463	50	87	27	103	160
821.164.050 S	5705499124057	50	87	27	103	160

BEND, LONG RADIUS 87.5°, 250 MM TYPE 821.090

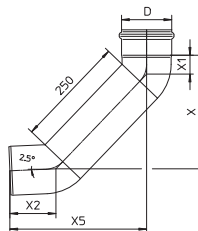

Type no.	EAN no.	D	X	X1	X2	X5	Kg
821.090.050	5705499408751	50	221	26	72	259	0,50
821.090.050 S	5705499408768	50	221	26	72	259	0,50
821.090.075	5705499408775	75	234	32	87	280	0,90
821.090.075 S	5705499408782	75	234	32	87	280	0,90
821.090.110	5705499401462	110	255	42	103	307	1,61
821.090.110 S	5705499401479	110	255	42	103	307	1,61
821.090.125	5705499412178	125	275	58	126	335	1,72
821.090.125 S	5705499412185	125	275	58	126	335	1,72
821.090.160	5705499401486	160	288	54	130	354	4,34
821.090.160 S	5705499401493	160	288	54	130	354	4,34

- Branches

BRANCH 87.5° TYPE 830

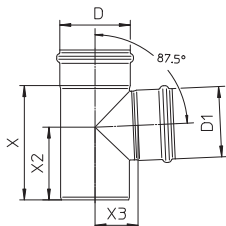

Type no.	EAN no.	D	D1	X	X2	X3	Kg
830.040.040	5705499412932	40	40	101	69	30	0,22
830.040.040 S	5705499412949	40	40	101	69	30	0,22
830.040.050	5705499412956	50	40	106	71	35	0,26
830.040.050 S	5705499412963	50	40	106	71	35	0,26
830.050.050	5705499401608	50	50	106	71	35	0,27
830.050.050 S	5705499401615	50	50	106	71	35	0,27
830.050.075	5705499401622	75	50	139	98	49	0,44
830.050.075 S	5705499401639	75	50	139	98	49	0,44
830.050.082	5705499411928	82	50	128	86	52	0,47
830.050.082 S	5705499411935	82	50	128	86	52	0,47
830.050.110	5705499401646	110	50	132	93	66	0,64
830.050.110 S	5705499401653	110	50	132	93	66	0,64
830.050.160	5705499401660	160	50	158	109	88	1,32
830.075.075	5705499401684	75	75	139	90	52	0,50
830.075.075 S	5705499401691	75	75	139	90	52	0,50
830.075.082	5705499411942	82	75	154	99	55	0,57
830.075.082 S	5705499411959	82	75	154	99	55	0,57
830.075.110	5705499401707	110	75	152	104	69	0,76
830.075.110 S	5705499401714	110	75	152	104	69	0,76
830.075.125	5705499408942	125	75	187	110	77	0,94
830.075.125 S	5705499408959	125	75	187	110	77	0,94
830.075.160	5705499412550	160	75	179	121	95	1,46
830.082.082	5705499411966	82	82	162	103	56	0,61
830.082.082 S	5705499411973	82	82	162	103	56	0,61
830.110.110	5705499401721	110	110	183	117	69	0,88
830.110.110 S	5705499401738	110	110	183	117	69	0,88
830.110.125	5705499408973	125	110	205	127	77	1,25
830.110.125 S	5705499408980	125	110	205	127	77	1,25
830.110.160	5705499401745	160	110	236	152	93	1,84
830.110.160 S	5705499401752	160	110	236	152	93	1,83
830.125.125	5705499409000	125	125	220	135	82	1,17
830.125.125 S	5705499409017	125	125	220	135	82	1,17
830.160.160	5705499401769	160	160	288	184	104	2,40
830.160.160 S	5705499401776	160	160	288	184	104	2,40
830.160.200 S	5705499411003	200	160	293	186	125	3,45
830.200.200 S	5705499411010	200	200	333	206	128	4,17
830.200.250 S	5705499121636	250	200	352	220	155	5,50
830.250.250 S	5705499121643	250	250	407	245	152	6,53

To comply with BS EN 12056 Gravity Drainage inside Buildings, when using non reducing branch consider branch type 838, 848 or 839

OBLIQUE BRANCH 45° TYPE 838

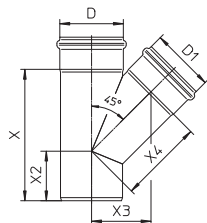

Type no.	EAN no.	D	D1	X	X2	X3	X4	Kg
838.040.040	5705499412994	40	40	118	58	45	63	0,25
838.040.040 S	5705499413007	40	40	118	58	45	63	0,25
838.040.050	5705499413014	50	40	119	55	50	71	0,30
838.040.050 S	5705499413021	50	40	119	55	50	71	0,30
838.050.050	5705499402353	50	50	133	62	54	76	0,32
838.050.050 S	5705499402360	50	50	133	62	54	76	0,32
838.050.075	5705499402377	75	50	144	56	66	94	0,48
838.050.075 S	5705499402384	75	50	144	56	66	94	0,48
838.050.082	5705499411980	82	50	149	57	72	102	0,54
838.050.082 S	5705499411997	82	50	149	57	72	102	0,54
838.050.110	5705499402391	110	50	147	42	84	119	0,70
838.050.110 S	5705499402407	110	50	147	42	84	119	0,70
838.075.075	5705499402414	75	75	183	78	78	110	0,64
838.075.075 S	5705499402421	75	75	183	78	78	110	0,64
838.075.082	5705499412000	82	75	185	75	81	114	0,70
838.075.082 S	5705499412017	82	75	185	75	81	114	0,70
838.075.110	5705499402438	110	75	181	60	95	135	0,88
838.075.110 S	5705499402445	110	75	181	60	95	135	0,88
838.075.125	5705499409314	125	75	200	65	100	141	1,32
838.075.125 S	5705499409321	125	75	200	65	100	141	1,32
838.082.082	5705499412024	82	82	195	80	83	118	0,75

Continues on next page

- Branches

OBLIQUE BRANCH 45° TYPE 838

Type no.	EAN no.	D	D1	X	X2	X3	X4	Kg
Continued from previous page								
838.082.082 S	5705499412031	82	82	195	80	83	118	0,75
838.110.110	5705499402452	110	110	236	91	105	149	1,16
838.110.110 S	5705499402469	110	110	236	91	105	149	1,16
838.110.125	5705499409338	125	110	250	90	110	155	1,50
838.110.125 S	5705499409345	125	110	250	90	110	155	1,50
838.110.160	5705499402476	160	110	258	80	131	186	2,11
838.110.160 S	5705499402483	160	110	258	80	131	186	2,11
838.125.125	5705499409352	125	125	273	103	120	170	1,49
838.125.125 S	5705499409369	125	125	273	103	120	170	1,49
838.160.160	5705499402490	160	160	331	120	156	220	3,04
838.160.160 S	5705499402506	160	160	331	120	156	220	3,04
838.160.200 S	5705499411027	200	160	359	123	177	250	4,37
838.200.200 S	5705499411034	200	200	415	151	194	274	5,47
838.200.250 S	5705499121650	250	200	432	142	217	307	6,61
838.250.250 S	5705499121667	250	250	512	177	236	334	8,57

- Access pipes and bends

BEND 87.5° WITH ACCESS TYPE 822

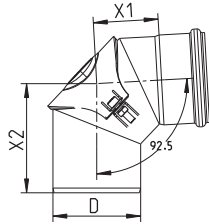

Type no.	EAN no.	D	X1	X2
822.090.075	5705499401509	75	57	102
822.090.075 S	5705499401516	75	57	102
822.090.110	5705499401523	110	81	137
822.090.110 S	5705499401530	110	81	137
822.090.160	5705499401547	160	112	205
822.090.160 S	5705499401554	160	112	205

For non pressurized system

PIPE WITH ACCESS TYPE 840

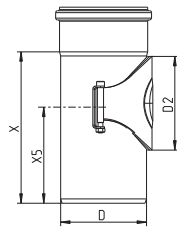

Type no.	EAN no.	D	D2	X	X5
840.075.075	5705499402674	75	80	139	92
840.075.075 S	5705499402681	75	80	139	92
840.110.110	5705499403794	110	120	194	123
840.110.110 S	5705499403800	110	120	194	123
840.111.110	5705499402698	110	120	253	187
840.111.110 S	5705499402704	110	120	253	187
840.125.125 S	5705499411058	125	120	195	128
840.160.160	5705499402711	160	120	277	208
840.160.160 S	5705499402728	160	120	277	208
840.200.200 S	5705499412215	200	120	288	208

For non pressurized system

- Sockets

DOUBLE COUPLING TYPE 841

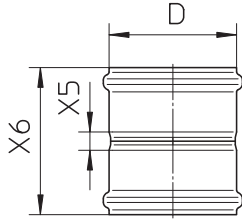

Type no.	EAN no.	D	X5	X6	Kg
841.040.040	5705499413038	40	20	104	0,13
841.040.040 S	5705499413045	40	20	104	0,13
841.050.050	5705499402735	50	13	97	0,15
841.050.050 S	5705499402742	50	13	97	0,15
841.075.075	5705499402759	75	20	120	0,26
841.075.075 S	5705499402766	75	20	120	0,26
841.082.082 S	5705499412048	82	20	124	0,31
841.110.110	5705499402773	110	16	130	0,45
841.110.110 S	5705499402780	110	16	130	0,45
841.125.125	5705499409475	125	20	140	0,54
841.125.125 S	5705499409482	125	20	140	0,54
841.160.160	5705499402797	160	20	162	1,05
841.160.160 S	5705499402803	160	20	162	1,05
841.200.200 S	5705499411065	200	20	200	1,85
841.250.250 S	5705499121674	250	30	246	3,11

DOUBLE SLIP COUPLING TYPE 842

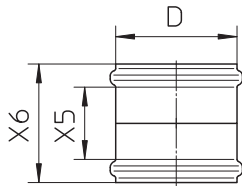

Type no.	EAN no.	D	X5	X6	Kg
842.040.040	5705499413052	40	76	104	0,13
842.040.040 S	5705499413069	40	76	104	0,13
842.050.050 S	5705499402810	50	71	97	0,12
842.075.075 S	5705499402827	75	91	120	0,21
842.082.082 S	5705499412055	82	95	124	0,31
842.110.110 S	5705499402834	110	97	130	0,45
842.125.125 S	5705499409550	125	104	140	0,47
842.160.160 S	5705499402841	160	118	162	1,05
842.200.200 S	5705499411072	200	147	200	1,82
842.250.250 S	5705499121681	250	173	264	3,11

EXPANSION SOCKET TYPE 843

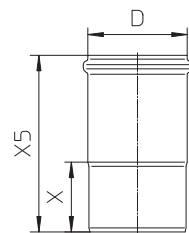

Type no.	EAN no.	D	X	X5	Kg
843.095.040	5705499413076	40	55	150	0,17
843.095.040 S	5705499413083	40	55	150	0,17
843.105.050	5705499402858	50	57	159	0,21
843.105.050 S	5705499402865	50	57	159	0,21
843.115.075	5705499402872	75	62	175	0,36
843.115.075 S	5705499402889	75	62	175	0,36
843.125.110	5705499402896	110	79	200	0,57
843.125.110 S	5705499402902	110	79	200	0,57
843.140.125	5705499122503	125	100	240	0,81
843.140.125 S	5705499122510	125	100	240	0,81
843.182.160	5705499402919	160	122	292	1,55
843.182.160 S	5705499402926	160	122	292	1,55

- Increases and reducers

INCREASER ECCENTRIC TYPE 850

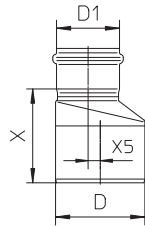

Type no.	EAN no.	D	D1	X	X5	Kg
850.040.050 S	5705499413397	50	40	85	5	0,16
850.050.075	5705499403084	75	50	87	7	0,22
850.050.075 S	5705499403091	75	50	87	7	0,22
850.050.082 S	5705499412062	82	50	97	14	0,25
850.050.110	5705499403107	110	50	114	25	0,38
850.050.110 S	5705499403114	110	50	114	25	0,38
850.075.110	5705499403138	110	75	116	15	0,42
850.075.110 S	5705499403152	110	75	116	15	0,42
850.075.160	5705499403169	160	75	178	37	1,20
850.075.160 S	5705499403176	160	75	178	37	1,20
850.082.110 S	5705499412086	110	82	111	11	0,43
850.110.125 S	5705499413410	125	110	109	8	0,49
850.110.160	5705499403206	160	110	140	22	1,06
850.110.160 S	5705499403213	160	110	140	22	1,06
850.125.160 S	5705499413427	160	125	138	18	0,95
850.160.200 S	5705499413434	200	160	165	20	1,67
850.200.250 S	5705499413441	250	200	195	25	2,57

INCREASER CONCENTRIC TYPE 850

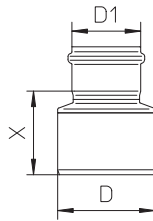

Type no.	EAN no.	D	D1	X	Kg
850.050.075 CS	5705499409734	75	50	82	0,20
850.050.110 CS	5705499408454	110	50	94	0,30
850.075.082 CS	5705499412079	82	75	96	0,29
850.075.110 C	5705499403145	110	75	95	0,37
850.075.110 CS	5705499409741	110	75	95	0,37
850.082.110 CS	5705499412093	110	82	110	0,40
850.110.125 CS	5705499409758	125	110	103	0,52
850.110.160 CS	5705499408461	160	110	117	1,00
850.125.160 CS	5705499408478	160	125	145	1,00
850.160.200 CS	5705499411096	200	160	170	1,00
850.200.250 CS	5705499121698	250	200	176	1,98

REDUCER ECCENTRIC TYPE 850

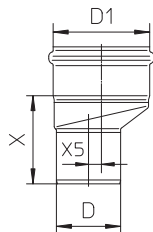

Type no.	EAN no.	D	D1	X	X5	Kg
850.050.040 S	5705499403961	40	50	77	5	0,10
850.075.050 S	5705499403121	50	75	80	7	0,28
850.110.050 S	5705499403183	50	110	99	25	0,50
850.110.075 S	5705499403190	75	110	104	15	0,55
850.110.082 S	5705499413342	82	110	101	11	0,29
850.125.110 S	5705499413359	110	125	96	8	0,49
850.160.110 S	5705499408485	110	160	123	22	1,08
850.160.125 S	5705499413366	125	160	136	18	0,97
850.200.160 S	5705499413373	160	200	153	20	1,77
850.250.200 S	5705499413380	200	250	189	25	2,78

REDUCER CONCENTRIC TYPE 850

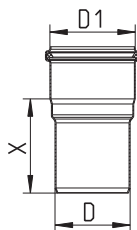

Type no.	EAN no.	D	D1	X
850.082.075 CS	5705499413465	75	82	94

- Rat stops

RAT STOP WITH ACCESS TYPE 891

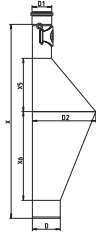

Type no.	EAN no.	D	D1	D2	X	X5	X6
891.075.110 S	5705499411492	110	75	250	764	210	350
891.110.110 S	5705499411508	110	110	250	814	210	350
891.125.125 S	5705499411515	125	125	250	836	210	350

For non pressurized system

RAT STOP WITHOUT ACCESS TYPE 892

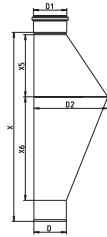

Type no.	EAN no.	D	D1	D2	X	X5	X6
892.075.110	5705499123425	110	75	250	678	210	350
892.075.110 S	5705499123449	110	75	250	678	210	350
892.110.110	5705499123432	110	110	250	640	210	350
892.110.110 S	5705499123456	110	110	250	640	210	350

Clamps

PIPE JOINT CLAMP TYPE 847

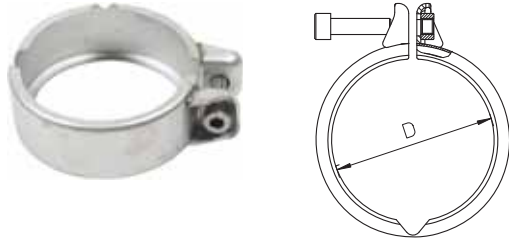

Type no.	EAN no.	D
847.040.040	5705499413090	40
847.050.050	5705499412420	50
847.075.075	5705499412437	75
847.082.082	5705499121322	82
847.110.110	5705499412444	110
847.125.125	5705499412451	125
847.160.160	5705499412468	160
847.200.200	5705499412475	200
847.250.250	5705499121773	250

CROSS RAKING FIXING FOR PIPE JOINT CLAMP TYPE 847

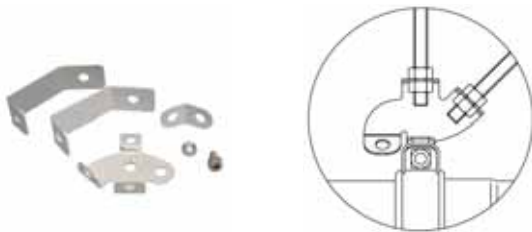

Type no.	EAN no.
847.000.000	5705499409628

Pipework system fitted with this product is suitable for up to +3 bar pressure and -0,85 bar vacuum

PRESSURE PEAK PIPE JOINT CLAMP TYPE 847.001

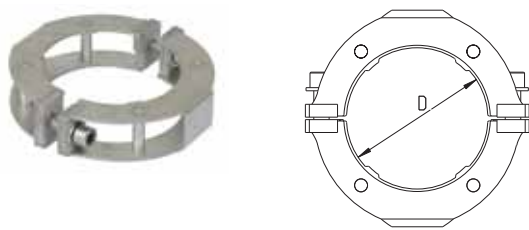

Type no.	EAN no.	D
847.001.040	5705499413106	40
847.001.050	5705499412499	50
847.001.075	5705499412505	75
847.001.082	5705499412512	82
847.001.110	5705499412529	110
847.001.125	5705499412536	125
847.001.160	5705499412543	160

If the system is designed to resist peak pressure then clamps must be fitted on all joints.
 Pipework D=40mm - D=110mm can withstand brief pressure peak up to +10 bar and
 D=125mm - D=160mm up to +7 bar when fitted with pressure peak pipe joint clamps

Pipe hangers

PIPE HANGER WITH TPE RUPPER TYPE 860

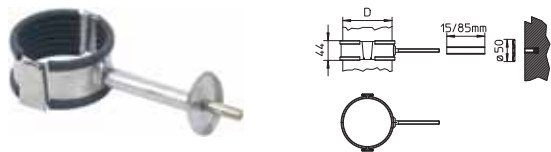

Type no.	EAN no.	D
860.040.050	5705499403350	50
860.040.075	5705499403367	75
860.040.110	5705499403374	110
860.040.160	5705499403381	160

PIPE HANGER WITH EPDM RUBBER TYPE 895.000

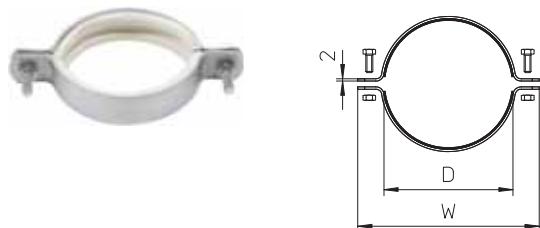

Type no.	EAN no.	D	W
895.000.050 GS	5705499403510	50	101
895.000.075 GS	5705499403527	75	126
895.000.110 GS	5705499403534	110	161
895.000.160 GS	5705499403541	160	211

PIPE HANGER WITH EPDM RUBBER TYPE 895.012

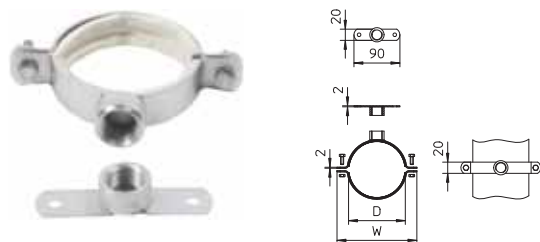

Type no.	EAN no.	D	W
895.012.040 GS	5705499413113	40	90
895.012.050 GS	5705499403558	50	101
895.012.075 GS	5705499403565	75	126
895.012.110 GS	5705499403572	110	161
895.012.160 GS	5705499403589	160	211

With 1/2" BSP thread.

PIPE HANGER WITH EPDM RUBBER TYPE 895.200

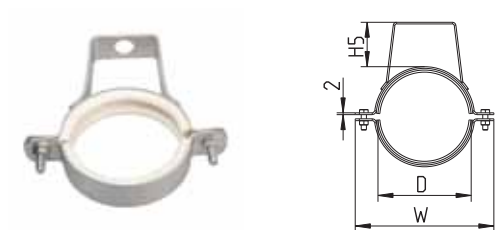

Type no.	EAN no.	D	H5	W
895.200.040 S	5705499413120	40	38	90
895.200.050 S	5705499410747	50	38	101
895.200.075 S	5705499410754	75	54	126
895.200.110 S	5705499410761	110	52	161
895.200.160 S	5705499410778	160	71	211

PIPE HANGER WITH EPDM RUBBER TYPE 895.401

IN GALVANIZED STEEL



Type no.	EAN no.	D	H	W	X5	T
895.401.040	5705499413144	40	20	83	41	1.25
895.401.050	5705499128024	50	20	97	49	1.25
895.401.075	5705499128031	75	23	122	61	2
895.401.110	5705499128048	110	23	157	78	2
895.401.125	5705499128055	125	23	169	84	2
895.401.160	5705499128062	160	25	233	108	3
895.401.200	5705499128079	200	25	273	122	3
895.401.250	5705499128086	250	38	345	163	4

D=75mm fits D=82mm as well.

MANUAL PIPE CUTTER

Cutting is done by a special disc cutter, which cuts and grips at the same time.

N.B.: Do not cut fittings.



Type no.	EAN no.	Designation
006.050.110	5705499000061	Manual pipe cutter (40 - 110 mm)
006.125.200	5705499001020	Manual pipe cutter (110 - 200 mm)
006.200.315	5705499123531	Manual pipe cutter (200 - 315 mm)
006.000.005	5705499000023	Spindle for pipe cutter 006.050.110
006.000.000	5705499000016	Cutting disc for pipe cutter 006.050.110
006.000.001	5705499001068	Cutting disc for pipe cutter 006.125.200

ELECTRICAL PIPE CUTTER

Cutting time:
Seconds.

Changeover time:
Changeover from one cutting disc to another can be effected within a matter of seconds.

Cutting quality:
The cutting motion has been developed to produce a bevelled leading edge to cut ends. As a result only the application of BLÜCHER jointing lubricant is required prior to jointing cut ends.

Power supply:
110 Volt/Min 2 kVA/60 Hz or 220 Volt/50 Hz.

Pipe diametres:
50-160 mm

N.B.: Do not cut fittings.



Type no.	EAN no.	Designation
800.050.160	5705499400021	Electrical pipe cutter 220 V
800.050.160 GB	5705499000184	Electrical pipe cutter 110 V, 16 A
800.050.160 US	5705499000191	Electrical pipe cutter 110 V, USA plug
800.030.006	5705499400014	Cutting disc
006.050.160	5705499124132	Support base for electrical pipe cutter

CUTTING OIL/JOINTING LUBRICANT

Jointing lubricant is applied to make jointing a simple action. After a few days the lubricant will dry out and lose its lubricity making subsequent demounting of a joint difficult. If subsequent demounting of joints can be envisaged then we can supply a silicone based lubricant that will not dry out. BLÜCHER jointing lubricant is based on a mild and harmless liquid detergent that is biologically degradable. BLÜCHER cutting oil is recommended for use with BLÜCHER® EuroPipe pipe cutters.



Type no.	EAN no.	Designation
007.000.000	5705499000078	Atomizer
007.100.050	5705499000085	Jointing lubricant 0.5 L
007.500.050	5705499000092	Cutting oil 0.5 L

Stainless steel



Long product life

Fire resistant

Lightweight

Hygienic

Long product life

- Corrosion resistant
- Resistant to impact damages
- Resistant to temperature variations

Fire resistant

- Non combustible
- No need for special fire insulation
- No toxic fumes are released in the event of a fire

Light-weight

- Low weight - high strength
- Weight only one third of cast iron
- Large pipes are easily handled by one man

Hygienic

- Low surface roughness
- High flow capacity
- Smooth surface prevents bacterial growth
- Smooth surface prevents blockages

Available in stainless steel AISI304/EN 1.4301 or AISI316L/EN 1.4404

Material properties of stainless steel

What is stainless steel?

The designation stainless steel covers a wide range of alloys with different properties. One property common to all stainless steels is that they contain at least 12% chromium.

The stainless steels can be divided into three main groups and a few mixed types according to the structure of the steel:

- Austenitic stainless steel
- Ferritic stainless steel
- Martensitic stainless steel

Austenitic stainless steel is the most important, representing approx. 90% of total stainless steel consumption. Austenitic steel is also the only stainless steel suitable for drainage installations, and it is, of course, the type used by BLÜCHER.

Importance of alloying elements

Austenitic stainless steel contains at least 18% chromium and 8% nickel – thus the well-known designation »18/8« steel. Corrosion resistance generally increases with increasing content of chromium. In alloys with 12-13% chromium, the passive layer is strong enough to prevent the steel from corroding in normal or mildly aggressive media. The main effect of the alloying element nickel is on the structure of the steel and its mechanical properties. The steel's structure is austenitic with an adequate content of nickel. In contrast to the pure chromium steels (ferritic stainless steel), this results in significant changes in the mechanical properties, such as increased workability and ductility, better resistance to thermal stress and improved weldability. The austenitic structure also results in a change in the physical properties of the steel. For example, the steel is not magnetic and has higher thermal conductivity.

Material Specification

Material	AISI 316 L 1.4404	AISI 304 1.4301
Analysis		
Carbon (C %)	Max. 0,03	Max. 0,07
Chromium (Cr %)	16,5 - 18,5	17,0 - 19,0
Nickel (Ni %)	11,0 - 14,0	8,5 - 10,5
Molybdenum (Mo %)	2,0 - 2,5	-
Manganese (Mn %)	Max. 2,0	Max. 2,0
Silicium (Si %)	Max. 1,0	Max. 1,0
Sulphur (S %)	Max. 0,030	Max. 0,030

Physical Properties

Structure	Austenitic (nonmagnetic)	Austenitic (nonmagnetic)
State	Non-annealed	
Specific gravity (g/cm ³)	7,98	7,9
Melting point (°C)	Ca. 1400	Ca. 1400
Decortication temperature in air (°C)	800 - 860	800 - 860
Expansion coefficient 20 - 100 °C (m/m · °C)	16,5 × 10 ⁻⁶	16,5 × 10 ⁻⁶
Specific resistance (20° C) (Ohm · mm ² /m)	0,75	0,73
Heat conductivity (20°C) (W/°C-m)	15	15
Specific heat (J/g · k)	0,5	0,5

Mechanical Properties

Ultimate tensile strength (Rm) (N/mm ²)	490 - 690	500 - 700
Yield point (Rp02) (N/mm ²)	190	195
Modulus of elasticity (E) (20° C) (N/mm ²)	2,0 × 10 ⁵	2,0 × 10 ⁵
Hardness Brinell (HB) (N/mm ²)	120 - 180	130 - 180

Nickel also increases resistance to corrosion caused by certain media. Molybdenum has the same effect on the structure as chromium, but it also has a strongly positive influence on corrosion resistance. Molybdenum-containing steel is normally designated »acid-resistant« because of the resistance of these steels to certain types of acids. But acid-resistant stainless steel will also have limited resistance to some media such as chlorine-containing media (see table of resistance).

Why is steel »stainless«?

The addition of chromium to the steel results in the formation of a passivating oxide film with a high content of chromium oxides.

This oxide film protects the surface of the steel against oxygen in air and water. An outstanding property of stainless steel is that the chromium oxide film automatically regenerates if the surface of the steel is exposed.

This restitution of the oxide film can only occur if the surface of the steel is completely clean and free of tempering agents and slag from welding processes and residues from tools made from ordinary carbon steel.

If this surface contamination is not removed, the steel may ultimately corrode. To prevent this, the steel surfaces should be cleaned after welding and processing, e.g. by means of so-called acid pickling of the stainless steel.

The pickling effectively removes all impurities from the surface of the steel and permits the reestablishment of a strong, uniform chromium oxide film. The pickling bath normally consists of 0.5-5% v/v HF (hydrofluoric acid) and 8-20% v/v HNO₃ (nitric acid) at a temperature of 25-60°C. This acid bath removes residues, the existing chromium oxide film and traces of iron, leaving the clean steel surface. The restitution of a strong chromium oxide film starts in the subsequent rinsing in water.

CHEMICAL RESISTANCE TABLE

The table is based on laboratory experiments with chemically pure sub-stances. The values should therefore be regarded as for guidance only.

	AISI 316 L Stainless	AISI 304 Stainless	EPDM	NBR	PPM
A = Very good service to operating limit of material					
B = Moderate service					
C = Limited or variable service					
D = Unsatisfactory					
Acetone	A	A	A	D	D
Acetic acid (dilute,) 30% or 50%	A	A	A	B	B
Acetic acid 100%	A	A	A	C	C
Acetic anhydride	A	A	B	C	D
Aluminium chloride	D	D	A	A	A
Aluminium sulfate	A	D	A	A	A
Ammonium carbonate	A	A	A	D	-
Ammonium chloride/salmiac	B	C	A	A	-
Ammonium hydroxide	A	A	A	D	B
Amyl chloride	A	A	-	-	-
Aniline	A	A	B	D	C
Anilin hydrochloride	D	D	B	B	B
Barium chloride	B	B	A	A	A
Barium hydroxide	A	A	A	A	A
Benzaldehyde	A	A	A	D	D
Benzene	A	A	D	D	A
Benzoic acid	A	A	-	-	A
Borax/sodium borat	A	A	A	B	A
Boric acid	A	A	A	A	A
Bromine	D	D	-	-	A
Bromine chloride	D	D	A	B	A
Bromoethylene/vinyl bromide	A	A	-	-	-
Butanol	A	A	D	A	A
Butyl acetat	A	A	B	-	D
Butyric acid	A	A	-	-	-
Calcium bisulfate	A	A	D	A	A
Calcium chloride	B	B	A	A	A
Calcium hydroxide	A	A	A	A	A
Calcium hypochlorite	B	C	A	C	A
Carbon disulfide	A	A	-	-	-
Carbon tetrachloride	A	A	D	C	A
Chloroacetic acid (Mono)	D	D	B	-	-
Chlorine (dry)	A	A	-	-	A
Chlorobenzene	A	A	D	D	A
Chlorosulfonic acid	B	C	D	D	C
Copper chloride	B	B	A	A	A
Copper nitrate	A	A	-	-	-
Copper sulfate	A	A	A	A	A
Ether	A	A	-	-	-
Ethyl chloride	A	A	A	A	A
Fatty acid	A	A	D	B	A
Fluorine (dry)	A	A	-	-	-
Hydrofluoric acid	D	D	B	D	A
Formaldehyde	A	A	A	B	A
Formic acid	A	A	A	B	C
Furfural	A	A	B	D	D
Gallic acid	A	A	B	B	A
Hydrobromic acid	D	D	A	D	A
Hydrochloric acid	D	D	A	D	A
Hydrogen peroxide	A	A	C	D	B
Iodine (wet)	D	D	-	-	-
Kloroform	B	B	D	D	A
Lead acetate	A	A	A	B	-
Magnesium chloride	B	B	A	A	A

VALUES TO BE REGARDED AS FOR GUIDANCE ONLY

	AISI 316 L Stainless	AISI 304 Stainless	EPDM	NBR	PPM
A = Very good service to operating limit of material					
B = Moderate service					
C = Limited or variable service					
D = Unsatisfactory					
Magnesium sulfate	A	A	A	A	A
Mercury	A	A	A	A	A
Methanol	A	A	A	A	C
Methyl chloride	A	A	C	D	A
Methylene chloride	B	B	D	D	B
Natphalene	A	A	D	D	A
Nickel chloride	B	B	A	A	A
Nickel sulfate	A	A	A	A	A
Nitric acid	C	C	C	D	A
Oxalic acid	C	C	A	B	A
Perchloric acid	D	D	B	-	A
Phosphoric acid	A	A	B	D	A
Picric acid	A	A	B	B	A
Potassium bromide	A	A	-	-	-
Potassium carbonate	A	A	-	-	-
Potassium chlorate	A	A	-	-	-
Potassium cyanide	A	A	A	A	A
Potassium hydroxide	A	A	A	B	B
Potassium nitrate	A	A	A	A	A
Potassium permanganate	A	A	-	-	-
Potassium sulfate	A	A	A	A	A
Potassium sulfide	A	A	-	-	-
Potassium chloride	B	B	A	A	A
Propylene dichloride	A	A	-	-	-
Silver nitrate	A	A	A	B	A
Soda (ash)/sodium	A	A	-	-	-
Sodium acetate	A	A	A	B	D
Sodium bicarbonate	A	A	A	A	A
Sodium bisulfate	A	C	-	-	-
Sodium bisulfite	A	A	A	A	A
Sodium bromide	B	B	-	-	-
Sodium chlorate	A	A	-	-	-
Sodium chloride	D	D	-	-	-
Sodium cyanide	A	A	A	A	A
Sodium fluoride	A	A	-	-	-
Sodium hydroxide	A	A	A	B	B
Sodium hypochlorite	D	D	B	B	A
Sodium nitrate	A	A	A	B	-
Sodium sulfate	A	A	A	A	A
Sodium sulfide	A	A	-	-	-
Sodium sulfite	A	A	-	-	-
Stannous chloride/tin chloride	B	C	B	A	A
Sulfur	A	A	A	D	A
Sulfur chloride	A	A	D	C	A
Sulfur dioxide	A	B	A	D	A
Sulfuric acid	D	D	B	D	A
Sulfurous acid	A	C	B	B	A
Thionyl chloride	A	A	D	-	A
Toluene/toluol	A	A	D	D	A
Trichloroethylene	A	A	D	C	A
Turpentine	A	A	D	A	A
Xylene/xylol	A	A	-	-	-
Zinc sulfate	A	A	-	-	-

VALUES TO BE REGARDED AS FOR GUIDANCE ONLY

Assumptions: 20°C room temperature

References

Corrosion Data Survey, 1969 Edition, Nace
 Corrosion Tables, Stainless Steels, 1979, Jernkontoret
 Chemical Resistance of Plastic Piping Materials, Cabot Corporation, 1979

PLEASE NOTE!

Concentration level, length of exposure, temperature and in particular the combination of several chemicals have a direct influence on the resistance of stainless steel to certain chemicals. Each application should therefore be carefully reviewed to determine the suitability of stainless steel.

In particular, be careful with the use of hydrous cleaning agents containing compounds of chlorine.

Material properties of rubber seals

Rubber types

International designation	EPDM	NBR	FPM
Rubber type	Ethylene propene	Nitrile	Fluorine (Viton)
Nominal hardness IRHD	60 (+/-5)	60 (+/-5)	60(+/-5)
Colour	Black	Black/yellow dot	Purple
Tensile strength MPa	≥ 10 N/mm ²	≥ 10 N/mm ²	≥ 8 N/mm ²
Elongation after fracture %	≥ 300%	≥ 300%	≥ 260%
Max. temperatur range	-35/+100° C	-30/+80° C	-25/+200° C

Resistance

Wearability	B	B	B
Resistance to mineral oil	D	A	A
Resistance to vegetable oil	B	A	A
Resistance to benzene/petrol	D	A	A
Resistance to aromatic compounds and hydrocarbons	D	B	A
Resistance to ketones	A	D	D
Resistance to ordinary diluted acids and alkalines	A	A	A
Resistance to ozone and weather stresses	A	C	A
Resistance to air diffusion	D	C	A

A = Very good service - B = Moderate service - C = Limited or variable service - D = Unsatisfactory

A lip sealing ring constitutes the seal between socket and spigot end. The lip sealing ring ensures quick and efficient jointing of the pipe system while providing a tight seal in case of both pressure and vacuum. The BLÜCHER® sealing rings are available in three different rubber qualities.

EPDM This sealing ring is black and made of ethylene propylene diene monomer rubber. This is BLÜCHER's standard sealing ring and it is suitable for all rainwater and waste water installations where there is no oil or petrol residues in the waste water. The EPDM lip seal is a good all-round rubber quality suitable for a wide range of applications.

NBR This sealing ring is black with a yellow spot and made from nitrile butadiene rubber and is the sealing ring to be used where there are petrol or oil residues in the waste water (e.g. in connection with oil and petrol separators at service stations, garages etc.). The NBR lip seal should not be used where there is a risk of temperatures above 80°C. NBR is not resistant to solvents.

FPM This sealing ring is purple and made from fluorine rubber (Viton®). This is BLÜCHER's sealing ring for special applications. The material is particularly heat-resistant and resistant to oil, solvents and strong acids. However, the FPM seal has only limited resistance to e.g. butyl acetate, acetone and methyl alcohol.

For advice regarding the suitability of the different rubber qualities, consult BLÜCHER.



Approvals

BLÜCHER has its own testing facilities and cooperates with internationally recognized independent institutes. At BLÜCHER we also play an active part in setting international standards.

The functionality of our products has been documented by test reports and approvals from international institutes such as Sitac (SE), LGA (DE), BBA (UK), VTT (FI), ETA (DK) etc.

All pipes and channels are CE marked.

For a complete list of all current product approvals we refer to www.blucher.com.

Furhermore, we use approved institutes for fire and sound testing, for instance DTI (DK) and Fraunhofer Institut (DE)

All production is carried out in Denmark in accordance with ISO 9001.

Maintenance

BLÜCHER stainless steel drainage products require only a minimum of maintenance.

The smooth, acid-pickled surface retains its uniform matt silver finish in most environments such as wet rooms, bathrooms and kitchens. However, in particularly demanding environments such as the food industry, laboratories, the chemical industry and agriculture, it may be necessary to clean the installation to avoid formation of coatings which can cause subsequent corrosion.

Cleaning can for instance be done by means of high pressure flushing. In some cases it may be necessary to use diluted citric acid. After use take care to rinse with plenty of water.

Please also notice that particularly aggressive and hazardous substances should be collected in containers and disposed of in another way and not through the drainage system.

Production

Excellent workmanship, common sense and the most sophisticated production technology are combined to ensure the highest quality in our products.



All BLÜCHER® products are tested for leakages before leaving the factory



The most modern piping machinery in Europe

Installation video at www.blucher.com

As a supplement to the printed installation instructions for the BLÜCHER® roof drainage system, an installation video is available at www.blucher.com (select the tab "Installation").

BLÜCHER® Roof Drainage System

Introduction to use and installation instructions







BLÜCHER®

At BLÜCHER® more than 300 employees create an annual turnover of more than 50 million euro.

Through know-how, dedicated service and common sense we develop, produce and market high quality stainless steel drainage solutions for customers within the housing, commercial, industrial and marine sectors all over the world.

Find your local BLÜCHER® specialist at www.blucher.com

BLÜCHER® EuroPipe

BLÜCHER® Channel

BLÜCHER® Drain



KEEPING UP THE FLOW